



**Manufacturers of Sewer Cleaning Equipment for
Wastewater and Storm Drain Collection Systems**



EQUIPMENT | TOOLS | ACCESSORIES



TABLE OF CONTENTS







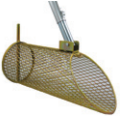

	ITEM	SECTION	PAGE #
	VAC-TRAP DEBRIS AND GRIT CATCHERS	1-6	1-2
	DEBRIS AND GRIT CATCHERS	7-11	3-4
	FIBERGLASS POLE ACCESSORIES	12-15	4
	FIBERGLASS POLE SETS	16-19	5
	MANHOLE CLEANING ACCESSORIES	20-22	6
	MAX-LIFE MANHOLE TOOLS	23-34	7-9
	CONTINUOUS ROD, PARTS, TOOLS, & ACCESSORIES	35-46	10-12
	HYDRAULIC ROOT CUTTERS	47	13
	HUBS	48	13
	SPECIAL TOOLS FOR SEPTIC USE	49	13
	SEWER GUIDE HOSES	50-53	14
	NOZZLE EXTENSIONS	54-62	15-16

TABLE OF CONTENTS

	ITEM	SECTION	PAGE #
	CONTINUOUS ROD, PARTS, TOOLS AND ACCESSORIES	63-72	17-18
	SPECIAL SEWER RODDER ACCESSORIES	73-76	19-20
	SEWER RODDING EQUIPMENT & ACCESSORIES	77-79	21
	MAX-LIFE MUNICIPAL SEWER RODS	80-83	22
	SEWER TOOLS FOR 5/16" & 3/8" RODS	84-105	23-29
	SPECIAL TOOLS FOR LINED PIPE	106-111	30
	SEWER TOOLS FOR 5/16" & 3/8" RODS	112-114	31
	CONTINUOUS ROD, PARTS, TOOLS AND ACCESSORIES	115-117	32
	MANUAL 1/4" X 6' PLUMBERS RODS & TOOLS	118-121	33-34
	MAX-LIFE BUCKET MACHINES	122-127	35-38
	NOTES		36

VAC-TRAP DEBRIS AND GRIT CATCHERS

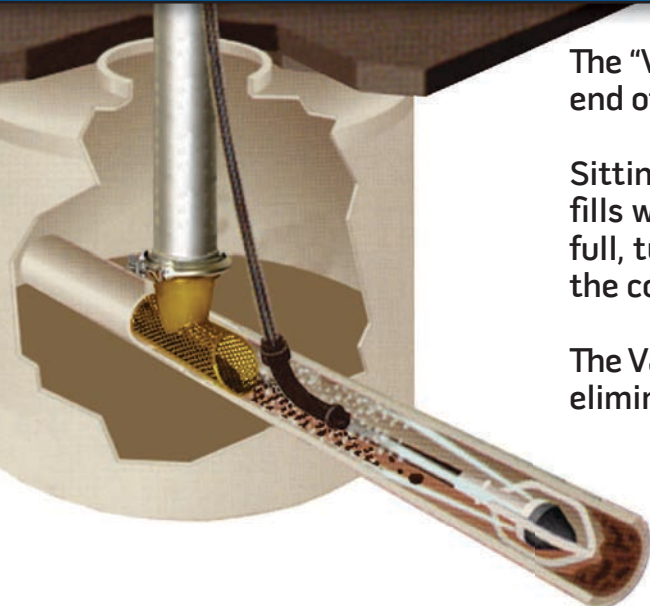

The "Vac-Trap." A new Debris and grit Trap that connects to the end of your suction tubes replacing the crown nozzle.

Sitting at the bottom of the invert in the manhole, the Vac-Trap fills with debris as water is flowing through it. Once the trap is full, turn off the water. Turn on the vacuum pump and vacuum the contents, then repeat the process.

The Vac-Trap lets water flow downstream. Saves decanting time eliminating the need to run the vacuum pump continuously.

AVAILABLE IN SIZES FROM 6" TO 24"

PATENT PENDING



VAC-TRAP DEBRIS CATCHER

8" VACTOR / VAC-CON

VTV-6	6" PIPE
VTV-8	8" PIPE
VTV-10	10" PIPE
VTV-12	12" PIPE
VTV-15	15" PIPE
VTV-18	18" PIPE
VTV-24	24" PIPE

6" VACTOR / VAC-CON

VTV6-6	6" PIPE
VTV6-8	8" PIPE
VTV6-10	10" PIPE
VTV6-12	12 PIPE
VTV6-15	15" PIPE
VTV6-18	18" PIPE
VTV6-24	24" PIPE



VAC-TRAP DEBRIS CATCHER

8" CAMEL / IRRIGATION

VTC-6	6" PIPE
VTC-8	8" PIPE
VTC-10	10" PIPE
VTC-12	12" PIPE
VTC-15	15" PIPE
VTC-18	18" PIPE
VTC-24	24" PIPE

6" CAMEL / IRRIGATION

VTC6-6	6" PIPE
VTC6-8	8" PIPE
VTC6-10	10" PIPE
VTC6-12	12" PIPE
VTC6-15	15" PIPE
VTC6-18	18" PIPE
VTC6-24	24" PIPE



VAC-TRAP DEBRIS CATCHER

8" AQUATECH

VTA-6	6" PIPE
VTA-8	8" PIPE
VTA-10	10" PIPE
VTA-12	12" PIPE
VTA-15	15" PIPE
VTA-18	18" PIPE
VTA-24	24" PIPE

6" AQUATECH

VTA6-6	6" PIPE
VTA6-8	8" PIPE
VTA6-10	10" PIPE
VTA6-12	12" PIPE
VTA6-15	15" PIPE
VTA6-18	18" PIPE
VTA6-24	24" PIPE

VAC-TRAP DEBRIS AND GRIT CATCHERS

4



VTGV

VAC-TRAP GRIT CATCHER

8" VACTOR / VAC-CON

VTGV-6	6" PIPE
VTGV-8	8" PIPE
VTGV-10	10" PIPE
VTGV-12	12" PIPE
VTGV-15	15" PIPE
VTGV-18	18" PIPE
VTGV-24	24" PIPE

6" VACTOR / VAC-CON

VTGV6-6	6" PIPE
VTGV6-8	8" PIPE
VTGV6-10	10" PIPE
VTGV6-12	12" PIPE
VTGV6-15	15" PIPE
VTGV6-18	18" PIPE
VTGV6-24	24" PIPE

5



VTGC

VAC-TRAP GRIT CATCHER

8" CAMEL / IRRIGATION

VTGC-6	6" PIPE
VTGC-8	8" PIPE
VTGC-10	10" PIPE
VTGC-12	12" PIPE
VTGC-15	15" PIPE
VTGC-18	18" PIPE
VTGC-24	24" PIPE

6" CAMEL / IRRIGATION

VTGC6-6	6" PIPE
VTGC6-8	8" PIPE
VTGC6-10	10" PIPE
VTGC6-12	12" PIPE
VTGC6-15	15" PIPE
VTGC6-18	18" PIPE
VTGC6-24	24" PIPE

6



VTGA

VAC-TRAP GRIT CATCHER

8" AQUATECH

VTGA-6	6" PIPE
VTGA-8	8" PIPE
VTGA-10	10" PIPE
VTGA-12	12" PIPE
VTGA-15	15" PIPE
VTGA-18	18" PIPE
VTGA-24	24" PIPE

6" AQUATECH

VTGA6-6	6" PIPE
VTGA6-8	8" PIPE
VTGA6-10	10" PIPE
VTGA6-12	12" PIPE
VTGA6-15	15" PIPE
VTGA6-18	18" PIPE
VTGA6-24	24" PIPE

DEBRIS AND GRIT CATCHERS

7

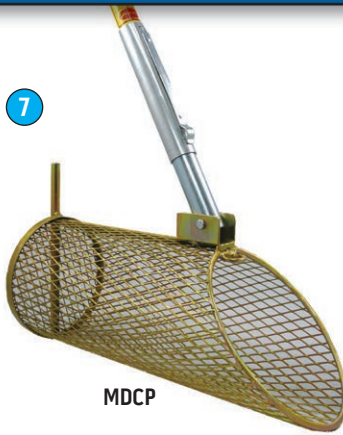

MDCP

DEBRIS CATCHERS FOR USE WITH FIBERGLASS POLES

MDCP-6	6" DEBRIS CATCHER FOR USE WITH FIBERGLASS POLE SETS	
MDCP-8	8" DEBRIS CATCHER FOR USE WITH FIBERGLASS POLE SETS	
MDCP-10	10" DEBRIS CATCHER FOR USE WITH FIBERGLASS POLE SETS	
MDCP-12	12" DEBRIS CATCHER FOR USE WITH FIBERGLASS POLE SETS	
MDCP-15	15" DEBRIS CATCHER FOR USE WITH FIBERGLASS POLE SETS	
MDCP-18	18" DEBRIS CATCHER FOR USE WITH FIBERGLASS POLE SETS	
MDCP-24	24" DEBRIS CATCHER FOR USE WITH FIBERGLASS POLE SETS	

8

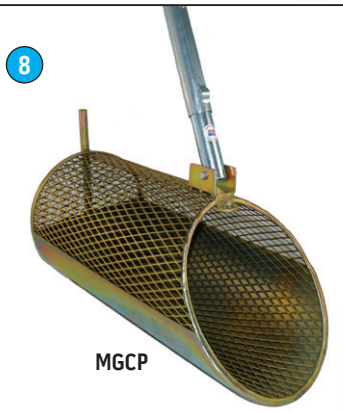

MGCP

GRIT CATCHERS FOR USE WITH FIBERGLASS POLES

MGCP-6	6" GRIT CATCHER FOR USE WITH FIBERGLASS POLE SETS	
MGCP-8	8" GRIT CATCHER FOR USE WITH FIBERGLASS POLE SETS	
MGCP-10	10" GRIT CATCHER FOR USE WITH FIBERGLASS POLE SETS	
MGCP-12	12" GRIT CATCHER FOR USE WITH FIBERGLASS POLE SETS	
MGCP-15	15" GRIT CATCHER FOR USE WITH FIBERGLASS POLE SETS	
MGCP-18	18" GRIT CATCHER FOR USE WITH FIBERGLASS POLE SETS	
MGCP-24	24" GRIT CATCHER FOR USE WITH FIBERGLASS POLE SETS	

9



MDC

DEBRIS CATCHERS WITH 25' POLY ROPE ATTACHED

MDC-6	6" DEBRIS CATCHER WITH 25' OF 3/8" POLY ROPE	
MDC-8	8" DEBRIS CATCHER WITH 25' OF 3/8" POLY ROPE	
MDC-10	10" DEBRIS CATCHER WITH 25' OF 3/8" POLY ROPE	
MDC-12	12" DEBRIS CATCHER WITH 25' OF 3/8" POLY ROPE	
MDC-15	15" DEBRIS CATCHER WITH 25' OF 3/8" POLY ROPE	
MDC-18	18" DEBRIS CATCHER WITH 25' OF 3/8" POLY ROPE	
MDC-24	24" DEBRIS CATCHER WITH 20' OF 3/8" POLY ROPE	

10



MGC

GRIT CATCHERS WITH 25' POLY ROPE ATTACHED

MGC-6	6" GRIT CATCHER COMPLETE WITH 25' OF 3/8" POLY ROPE	
MGC-8	8" GRIT CATCHER COMPLETE WITH 25' OF 3/8" POLY ROPE	
MGC-10	10" GRIT CATCHER COMPLETE WITH 25' OF 3/8" POLY ROPE	
MGC-12	12" GRIT CATCHER COMPLETE WITH 25' OF 3/8" POLY ROPE	
MGC-15	15" GRIT CATCHER COMPLETE WITH 25' OF 3/8" POLY ROPE	
MGC-18	18" GRIT CATCHER COMPLETE WITH 25' OF 3/8" POLY ROPE	
MGC-24	24" GRIT CATCHER COMPLETE WITH 25' OF 3/8" POLY ROPE	

DEBRIS AND GRIT CATCHERS

DEBRIS BASKET CYLINDERS FOR USE WITH FIBERGLASS POLES

MGBC-6	6" DEBRIS BASKET CYLINDER	
MGBC-8	8" DEBRIS BASKET CYLINDER	
MGBC-10	10" DEBRIS BASKET CYLINDER	
MGBC-12	12" DEBRIS BASKET CYLINDER	
MGBC-15	15" DEBRIS BASKET CYLINDER	
MGBC-18	18" DEBRIS BASKET CYLINDER	
MGBC-24	24" DEBRIS BASKET CYLINDER	



11

FIBERGLASS POLE ACCESSORIES

DOUBLE POLE HOLDER SET

DPHS-2	DOUBLE POLE HOLDER SET	
--------	------------------------	--



12

SINGLE POLE HOLDER SET

SPHS-1	SINGLE POLE HOLDER SET	
--------	------------------------	--



13

STEEL THREADED COUPLINGS

FPTC-1	FIBERGLASS POLE THREADED COUPLING SET	
FPTC-S	FIBERGLASS POLE THREADED COUPLING SINGLE	



14

STEEL THREADED COUPLINGS

ACTA-1	ADAPTER CLIP/THREAD ASSEMBLY	
--------	------------------------------	--



15

FIBERGLASS POLE SETS

16



MFPG



GREEN FOAM FILLED FIBERGLASS QUICK COUPLING POLE SETS

MFPG-6	6' GREEN FOAM FILLED FIBERGLASS POLE	
MFPG-12	12' GREEN FOAM FILLED FIBERGLASS POLE.	
MFPG-24	24' GREEN FOAM FILLED FIBERGLASS POLE SET. LIGHT WEIGHT WITH ALUMINUM QUICK COUPLINGS.	
	INCLUDES: 4 EA. OF 6 FOOT FIBERGLASS POLE.	

17



MFP

MFP



STEEL REINFORCED FIBERGLASS QUICK COUPLING POLE SETS

MFP-6ST	6' STEEL YELLOW REINFORCED FIBERGLASS POLE.	
MFP-12ST	12' STEEL YELLOW REINFORCED FIBERGLASS POLE.	
MFP-24ST	24' FIBERGLASS POLE SET WITH STEEL INTERNAL REINFORCEMENT.	

STEEL REINFORCED FIBERGLASS THREADED COUPLING POLE SETS

MFPTC-6	6' YELLOW FIBERGLASS POLE W/STEEL REINFORCEMENT W/ M X F STEEL THREADED COUPLINGS	
MFPTC-12	12' YELLOW FIBERGLASS POLE W/STEEL REINFORCEMENT W/ M X F THREADED COUPLINGS	
MFPTC-24	24' YELLOW FIBERGLASS POLE W/STEEL REINFORCEMENT W/ M X F STEEL THREADED COUPLINGS.	
	INCLUDES: 4 EA OF 6 FOOT FIBERGLASS POLE.	

PATENT PENDING

MFPTC

18

MAX-CLAW

MCLAW	7' TO 15' TELESCOPIC EXTENDABLE FIBERGLASS POLE WITH 3 PRONG SPRING LOADED HEAVY DUTY CLAW END. JAWS STAY OPEN TO CAPTURE DEBRIS, PULL ROPE THROUGH POSITIVE LOCK TO CLOSE THE JAWS.	
-------	--	--

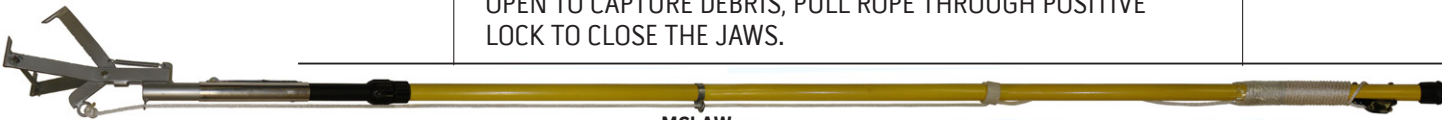

MCLAW

19

EXTENDABLE DEBRIS GRABBER 5' - 15'

MDG-1	5' - 15' EXTENDABLE DEBRIS GRABBER. ROPE AND 2 PRONGED TEETH WITH PICK UP BAR.	
MDG-2	7' - 21' EXTENDABLE DEBRIS GRABBER. ROPE AND 2 PRONGED TEETH WITH PICK UP BAR.	



MDG

MANHOLE CLEANING ACCESSORIES

CATCH BASIN SPOON

FBG	FBG ST	DESCRIPTION	FBG	FBG ST
MBS-6	MBS-6ST	6' FIBERGLASS POLE		
MBS-12	MBS-12ST	12' FIBERGLASS POLE SET		
MBS-18	MBS-18ST	18' FIBERGLASS POLE SET		
MBS-24	MBS-24ST	24' FIBERGLASS POLE SET		

FBG = FIBERGLASS POLE AND ST = STEEL REINFORCED



20

MBS

STRAIGHT INVERT SHOVEL

FBG	FBG ST	DESCRIPTION	FBG	FBG ST
MIS-6	MIS-6W	6' FIBERGLASS POLE		
MIS-12	MIS-12W	12' FIBERGLASS POLE SET		
MIS-18	MIS-18W	18' FIBERGLASS POLE SET		
MIS-24	MIS-24W	24' FIBERGLASS POLE SET		

FBG = FIBERGLASS POLE AND ST = STEEL REINFORCED



21

MIS

VERSI-CLAMS (UPS-ABLE) SPECIFY 12" OR 16" BUCKET

12"	16"	DESCRIPTION	USE AS	EACH
MHC-12-6	MHC-16-6	6 FOOT	6 footer	
MHC-12-7	MHC-16-7	7 FOOT	6, 7 footer	
MHC-12-8	MHC-16-8	8 FOOT	6, 8 footer	
MHC-12-9	MHC-16-9	9 FOOT	6, 9 footer	
MHC-12-10	MHC-16-10	10 FOOT	6, 10 footer	
MHC-12-11	MHC-16-11	11 FOOT	6, 11 footer	
MHC-12-12	MHC-16-12	12 FOOT	6, 12 footer	
MHC-12-14	MHC-16-14	14 FOOT	6, 12 or 14'	
MHC-12-16	MHC-16-16	16 FOOT	6, 12 or 16'	
MHC-12-17	MHC-16-17	17 FOOT	6, 12 or 17'	
MHC-12-18	MHC-16-18	18 FOOT	6, 12 or 18'	
MHC-12-20	MHC-16-20	20 FOOT	6, 12, 18, 20'	
MHC-12-25	MHC-16-25	25 FOOT	6, 12, 18, 25'	



22

KNOCK-DOWN DESIGN SO ALL SIZES CAN BE SHIPPED VIA UPS FOR "BIG SAVINGS"

EXTENSIONS CAN BE ORDERED FOR \$30.00 /FOOT

MHC

MAX-LIFE MANHOLE TOOLS

23



MLHG-1

HOSE GRABBER

This is the idea tool for retrieving your sewer hose, skid and nozzle, its' opposing rounded "C" hooks secure hose making grabbing it easy work. Available in [Clip coupling](#) and [Threaded coupling](#).

MLHG-1	HOSE GRABBER WITH COUPLING	
--------	----------------------------	--

24

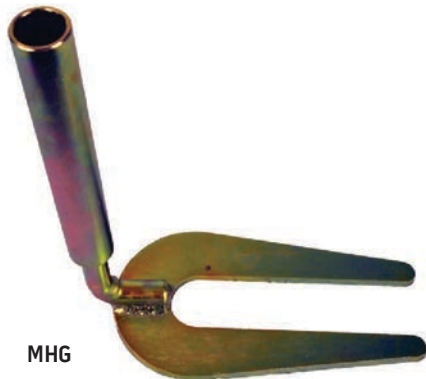

MHG

HORSE SHOE GRABBER

A great tool for use in drop manholes for starting the nozzle into the line. Available in [Clip coupling](#) or [Threaded coupling](#).

MHG-2	HORSE-SHOE GRABBER WITH COUPLING	
-------	----------------------------------	--

25

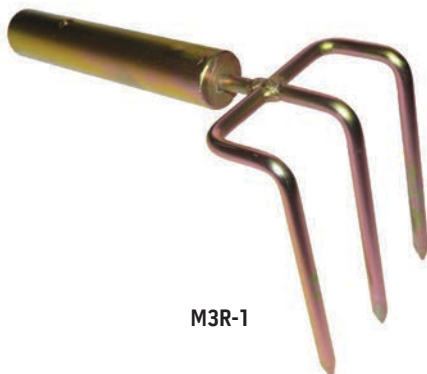

M3R-1

3 PRONG 90 DEGREE RAKE

This 3 prong rake with 90 degree bend is ideal for grabbing roots and debris from the bottom of the manhole or stromdrain debris. Available in [Clip coupling](#) and [Threaded coupling](#).

M3R-1	3-PRONGED 90° GRABBER WITH COUPLING	
-------	-------------------------------------	--

26

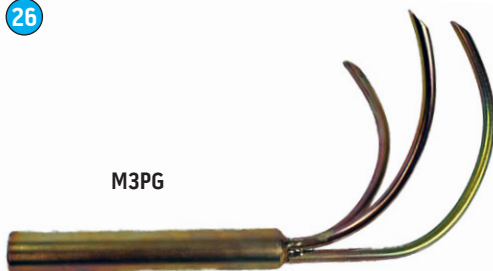

M3PG

3-PRONGED GRABBER

Pull out roots, rock and other hard to grab debris with ease. Available in [Clip coupling](#) or [Threaded coupling](#).

M3PG-1	3-PRONGED GRABBER WITH COUPLING	
--------	---------------------------------	--

MAX-LIFE MANHOLE TOOLS

DEBRIS SCOOPER

Heavy duty made to last and fits into the size of the sewer line to ensure debris is captured. Available in **Clip coupling** or **Threaded coupling**.

MDS-6	6" DEBRIS SCOOPER WITH COUPLING	
MDS-8	8" DEBRIS SCOOPER WITH COUPLING	
MDS-10	10" DEBRIS SCOOPER WITH COUPLING	



27

MDS

GREASE LOG CHOPPER

An excellent tool used to chop up large blocks of grease that float back while jetting. Also can be used for scraping walls in pump and lift stations. Available in **Clip coupling** or **Threaded coupling**.

MGLC-1	GREASE LOG CHOPPER	
--------	--------------------	--

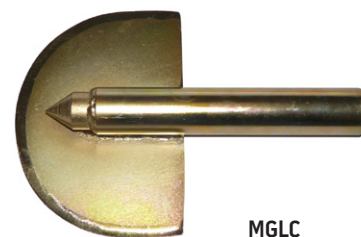

28

MGLC

CATCH BASIN SPOON

Here is an all time hard work tool. It has been around for a long time. It gets into the bottom of the manhole or the storm drain and makes easy work of scooping out debris. Available in **Clip coupling** or **Threaded coupling**.

MBC-1	CATCH BASIN SPOON FOR USE WITH POLE SET	
-------	---	--



29

MBC

CAMERA HOOK

Excellent for grabbing the bridal on the camera and pulling it back into the bottom of the manhole. Also use it to retrieve sewer hose. Available in **Clip coupling** or **Threaded coupling**.

CH-1	CAMERA HOOK TOOL	
------	------------------	--

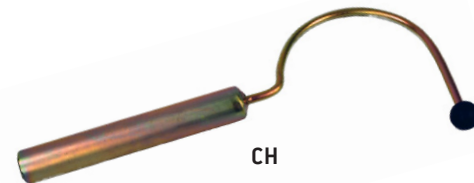

30

CH

GRAPPLING HOOK

The grappling hook is an excellent tool for retrieving large debris from the manhole or storm drain. The grappling hook comes with a 25' poly rope attached. The Hook is also **hardened** for extra strength.

MMH-1	GRAPPLING HOOK WITH 20' OF POLY ROPE	
-------	--------------------------------------	--



31

MMH

MAX-LIFE MANHOLE TOOLS

32



SAND TRAP ELBOWS

The reliable sand trap now comes with the ability to be attached to the fiberglass poles. This allows for better placement of the trap into the line and easy of retrieval out of the line. Available in **Clip coupling** or **Threaded coupling**.

MST-6	6" STEELSAND TRAP	
MST-8	8" STEELSAND TRAP	
MST-10	10" STEELSAND TRAP	
MST-12	12" STEELSAND TRAP	
MST-15	15" STEELSAND TRAP	
MST-18	18" STEELSAND TRAP	

33

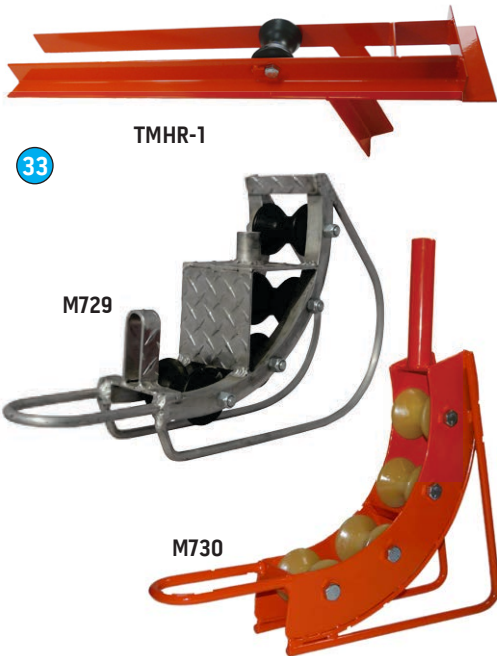

MANHOLE ROLLERS

TMHR-1	TOP ALUMINUM MANHOLE ROLLER Orange powder coated finish. Strong, lightweight 11 LBS. aluminum with 4" center roller.	
M729	LOWER MANHOLE ROLLER SHOE FOR CCTV Strong all aluminum construction provides smooth hose transition. 3/4" threaded connection for use with THD fiberglass poles.	
M730	POWDER COATED STEEL DOWN HOLE ROLLER. 4 heavy duty poly rollers. Max-life steel female coupling allows for use with fiberglass pole set.	
FA-1	FIBERGLASS POLE ADAPTER	

34



MANHOLE HOOKS

CST-1	CITY STYLE WITH "T" HANDLE 36" LONG WITH CURVED MACHINED END	
CSO-1	CITY STYLE WITH "O" HANDLE 36" LONG WITH CURVED MACHINED END	
MSRH-1	CAPTAIN HOOK STYLE WITH "TRIANGLE" HANDLE 36" LONG WITH HOOK ON END	

CONTINUOUS ROD, PARTS, TOOLS, & ACCESSORIES

CONTINUOUS WIRE (PRICES PER FOOT)

MCW-2	.375 CONTINUOUS ROD	
MCW-3	.393 CONTINUOUS ROD	
MCW-4	.415 CONTINUOUS ROD	
MCW-5	.461 CONTINUOUS ROD	
RLF-HD	ROD LOADING FRAME HEAVY DUTY 6 SPOKE	



ROD BENDING KITS

RBK-1	ROD BENDING KIT FOR .375 WIRE	
RBK-2	ROD BENDING KIT FOR .393 WIRE	
RBK-3	ROD BENDING KIT FOR .415 WIRE	
RBK-4	ROD BENDING KIT FOR .461 WIRE	



PIPE CLEANING TOOLS

SET SCREW	DIRECT HOOK		SET SCREW	DIRECT HOOK
MSP-18S	MSP-18D	SPEAR HEAD 2"		
MSP-28S	MSP-28D	SPEAR HEAD 4"		
MSL-38S	MSL-38D	SAND LEADER		
MBT-18S	MBT-18D	BULLET TOOL		
MBTS-1	MBTS-18D	SWIVEL BULLET PULL OUT TOOL		
MWR-SS	MWR-DH	WINTERS DOUBLE ROOT SAW COUPLING		



FOR .375 use "1" after part numbers, "2" for .393, "3" for .415 and "4" for .461

MISCELLANEOUS RODDING ITEMS

MPLY-1	SNAP ON PLIERS FOR CLEANING ROD	
MPLY-2	SPARE WIPER FELT	
CWPU	CONTINUOUS WIRE PICK UP TOOL WITH 3/8" COARSE THREAD NUT ON END.	
FD-1	FEED DOGS (CHROME VANADIUM) Includes pins and side links	
FRCC-1	COMPLETE CHAIN DRIVE WITH DOGS 30" RODS	



39



MRTS

STANDARD THICKNESS FLAT ROOT SAW

SET SCREW	DIRECT HOOK		
MRTS-3	MRTH-38	3" PIPE SIZE ROOT SAW	
MRTS-4	MRTH-48	4" PIPE SIZE ROOT SAW	
MRTS-5	MRTH-58	5" PIPE SIZE ROOT SAW	
MRTS-6	MRTH-68	6" PIPE SIZE ROOT SAW	
MRTS-8	MRTH-88	8" PIPE SIZE ROOT SAW	
MRTS-10	MRTH-108	10" PIPE SIZE ROOT SAW	
MRTS-12	MRTH-128	12" PIPE SIZE ROOT SAW	
MRTS-15	MRTH-158	15" PIPE SIZE ROOT SAW	
MRTS-18	MRTH-188	18" PIPE SIZE ROOT SAW	

For .375 add "1" after part numbers, "2" for .393, "3" for .415 and "4" for .461

40



MRTH

STANDARD THICKNESS CONCAVE ROOT SAWS

SET SCREW	DIRECT HOOK		
MRTS-3C	MRTH-3C	3" PIPE SIZE ROOT SAW	
MRTS-4C	MRTH-4C	4" PIPE SIZE ROOT SAW	
MRTS-5C	MRTH-5C	5" PIPE SIZE ROOT SAW	
MRTS-6C	MRTH-6C	6" PIPE SIZE ROOT SAW	
MRTS-8C	MRTH-8C	8" PIPE SIZE ROOT SAW	
MRTS-10C	MRTH-10C	10" PIPE SIZE ROOT SAW	
MRTS-12C	MRTH-12C	12" PIPE SIZE ROOT SAW	
MRTS-15C	MRTH-15C	15" PIPE SIZE ROOT SAW	
MRTS-18C	MRTH-18C	18" PIPE SIZE ROOT SAW	
MRTS-20C	MRTH-20C	20" PIPE SIZE ROOT SAW	

For .375 add "1" after part numbers, "2" for .393, "3" for .415 and "4" for .461

41



DMS

DURA-MAX FLAT ROOT SAWS ^{3/16"} Thick for Extra Flexibility Extra Deep Teeth

SET SCREW	DIRECT HOOK		
DMS-3	DMH-3	3" PIPE SIZE ROOT SAW	
DMS-4	DMH-4	4" PIPE SIZE ROOT SAW	
DMS-5	DMH-5	5" PIPE SIZE ROOT SAW	
DMS-6	DMH-6	6" PIPE SIZE ROOT SAW	
DMS-8	DMH-8	8" PIPE SIZE ROOT SAW	
DMS-10	DMH-10	10" PIPE SIZE ROOT SAW	
DMS-12	DMH-12	12" PIPE SIZE ROOT SAW	
DMS-15	DMH-15	15" PIPE SIZE ROOT SAW	
DMS-18	DMH-18	18" PIPE SIZE ROOT SAW	

For .375 add "1" after part numbers, "2" for .393, "3" for .415 and "4" for .461

42



DMH

DURA-MAX CONCAVE ROOT SAWS ^{3/16"} Thick for Extra Flexibility Extra Deep Teeth

SET SCREW	DIRECT HOOK		
DMS-3C	DMH-3C	3" PIPE SIZE ROOT SAW	
DMS-4C	DMH-4C	4" PIPE SIZE ROOT SAW	
DMS-5C	DMH-5C	5" PIPE SIZE ROOT SAW	
DMS-6C	DMH-6C	6" PIPE SIZE ROOT SAW	
DMS-8C	DMH-8C	8" PIPE SIZE ROOT SAW	
DMS-10C	DMH-10C	10" PIPE SIZE ROOT SAW	
DMS-12C	DMH-12C	12" PIPE SIZE ROOT SAW	
DMS-15C	DMH-15C	15" PIPE SIZE ROOT SAW	
DMS-18C	DMH-18C	18" PIPE SIZE ROOT SAW	

For .375 add "1" after part numbers, "2" for .393, "3" for .415 and "4" for .461

CONTINUOUS ROD, PARTS, TOOLS, & ACCESSORIES

SHARK TOOTH ROOT SAW

SET SCREW	DIRECT HOOK	
STSS-3	STSH-3	3" PIPE SIZE
STSS-4	STSH-4	4" PIPE SIZE
STSS-6	STSH-6	6" PIPE SIZE
STSS-8	STSH-8	8" PIPE SIZE
STSS-10	STSH-10	10" PIPE SIZE
STSS-12	STSH-12	12" PIPE SIZE

For .375 add "1" after part numbers, "2" for .393, "3" for .415 and "4" for .461



STSS

43

AUGERS

SET SCREW	DIRECT HOOK		SET SCREW	DIRECT HOOK
DA-2	HA-2	2" PIPE SIZE		
DA-3	HA-3	3" PIPE SIZE		
DA-4	HA-4	4" PIPE SIZE		
DA-5	HA-5	5" PIPE SIZE		
DA-6	HA-6	6" PIPE SIZE		
DA-8	HA-8	8" PIPE SIZE		
DA-10	HA-10	10" PIPE SIZE		

For .375 add "1" after part numbers, "2" for .393, "3" for .415 and "4" for .461



DA

44

SQUARE BAR CORKSCREWS

SET SCREW	DIRECT HOOK		SET SCREW	DIRECT HOOK
DSS-2	HSS-2	2" PIPE SIZE		
DSS-3	HSS-3	3" PIPE SIZE		
DSS-4	HSS-4	4" PIPE SIZE		
DSS-5	HSS-5	5" PIPE SIZE		
DSS-6	HSS-6	6" PIPE SIZE		
DSS-7	HSS-7	7" PIPE SIZE		
DSS-8	HSS-8	8" PIPE SIZE		
DSS-10	HSS-10	10" PIPE SIZE		
DSS-12	HSS-12	12" PIPE SIZE		

For .375 add "1" after part numbers, "2" for .393, "3" for .415 and "4" for .461



DSS

45

TURN TYPE PORCUPINES

SET SCREW	DIRECT HOOK		SET SCREW	DIRECT HOOK
MPTT-6S	MPTT-1D	6" PIPE SIZE		
MPTT-8S	MPTT-8D	8" PIPE SIZE		
MPTT-10S	MPTT-10D	10" PIPE SIZE		
MPTT-12S	MPTT-12D	12" PIPE SIZE		

For .375 add "1" after part numbers, "2" for .393, "3" for .415 and "4" for .461

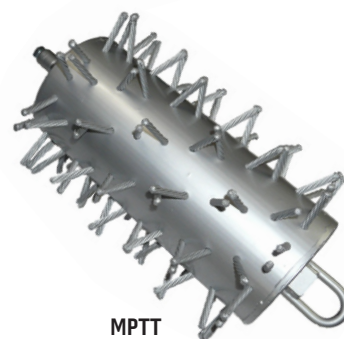

MPTT

46

HYDRAULIC ROOT CUTTERS

47



LARGE DIAMETER CONCAVE SPOKE ROOT SAWS FOR HYD ROOT CUTTERS

MRT-15SC	15" CONCAVE ROOT FOR 1" HYD. CUTTER HUB	
MRT-18SC	18" CONCAVE ROOT FOR 1" HYD. CUTTER HUB	
MRT-20SC	20" CONCAVE ROOT FOR 1" HYD. CUTTER HUB	
MRT-22SC	22" CONCAVE ROOT FOR 1" HYD. CUTTER HUB	
MRT-24SC	24" CONCAVE ROOT FOR 1" HYD. CUTTER HUB	

HUBS

48



VHYD-3



MHYD-1

HYDRAULIC ROOT CUTTER HUBS

MHYD-1	SAW HUB 1"	
MHYD-2	SAW HUB 5/8"	
VHYD-3	VERSI-CHUCK HUB 1"	
VHYD-4	VERSI-CHUCK HUB 5/8"	

SPECIAL TOOLS FOR SEPTIC USE

49

TOOLS FOR SEPTIC USE

All come with 3/4" female threaded connection to be used with aluminum or galvanized poles can be used with Fiberglass poles with FA-1 adapter.

MSS-9	9" SLUDGE SPUD	
MSS-15	15" SLUDGE SPUD	
MSH-9	9" SLUDGE HOE WITH 2 HOLES	
MSH-15	15" SLUDGE HOE WITH 3 HOLES	
MCS-9	9" CURVED SPUD	
MCS-15	15" CURVED SPUD	
TS-16	16" TANK SCRAPER	
MSR-12	12" SLUDGE RAKE 2 HOLES	
FA-1	FIBERGLASS POLE ADAPTER. THIS ADAPTER THREADS INTO SEPTIC TOOLS AND ALLOWS QUICK CONNECT TO FIBERGLASS POLES.	

SEWER GUIDE HOSES

BLUE LIGHTWEIGHT HOSE GUIDE WITH FLEX-METALLIC LINER

ALUM.	STEEL			
MRG-7	MRG-7S	7' HOSE GUIDE COMPLETE		
MRG-10	MRG-10S	10' HOSE GUIDE COMPLETE		
MRG-15	MRG-15S	15' HOSE GUIDE COMPLETE		
MRG-18	MRG-18S	18' HOSE GUIDE COMPLETE		
MRG-20	MRG-20S	20' HOSE GUIDE COMPLETE		
MRG-22	MRG-22S	22' HOSE GUIDE COMPLETE		
MRG-25	MRG-25S	25' HOSE GUIDE COMPLETE		



50

MRG

BLACK H.D. HOSE GUIDE WITH FLEX-METALLIC LINER

ALUM.	STEEL			
MRGB-7	MRGB-7S	7' HOSE GUIDE COMPLETE		
MRGB-10	MRGB-10S	10' HOSE GUIDE COMPLETE		
MRGB-15	MRGB-15S	15' HOSE GUIDE COMPLETE		
MRGB-18	MRGB-18S	18' HOSE GUIDE COMPLETE		
MRGB-20	MRGB-20S	20' HOSE GUIDE COMPLETE		
MRGB-22	MRGB-22S	22' HOSE GUIDE COMPLETE		
MRGB-25	MRGB-25S	25' HOSE GUIDE COMPLETE		



51

STEEL ENDS

MRGB

BELOW FREEZING HOSE GUIDE W/SPECIAL FLEX-METALLIC LINER

ALUM.	STEEL			
MRG-7BF	MRG-7BFS	7' HOSE GUIDE COMPLETE		
MRG-10BF	MRG-10BFS	10' HOSE GUIDE COMPLETE		
MRG-15BF	MRG-15BFS	15' HOSE GUIDE COMPLETE		
MRG-18BF	MRG-18BFS	18' HOSE GUIDE COMPLETE		
MRG-20BF	MRG-20BFS	20' HOSE GUIDE COMPLETE		
MRG-22BF	MRG-22BFS	22' HOSE GUIDE COMPLETE		
MRG-25BF	RG-25BFS	25' HOSE GUIDE COMPLETE		



52

MRG

SHOWN WITH ALUMINUM ENDS, STEEL AVAIL.

SUPER H.D. BLACK ROD GUIDE HOSE WITH H.D. STEEL SPRING LINER

ALUM.	STEEL			
MRGHD-7	MRGHD-7S	7' HOSE GUIDE COMPLETE		
MRGHD-10	MRGHD-10S	10' HOSE GUIDE COMPLETE		
MRGHD-15	MRGHD-15S	15' HOSE GUIDE COMPLETE		
MRGHD-18	MRGHD-18S	18' HOSE GUIDE COMPLETE		
MRGHD-20	MRGHD-20S	20' HOSE GUIDE COMPLETE		
MRGHD-22	MRGHD-22S	22' HOSE GUIDE COMPLETE		
MRGHD-25	MRGHD-25S	25' HOSE GUIDE COMPLETE		



53

STEEL ENDS

MRGHD

NOZZLE EXTENSIONS

54



STRAIGHT STYLE NOZZLE EXTENSION

1" size	3/4" size		
MSSE-1	MSSE-34	NOZZLE EXTENSION	

55

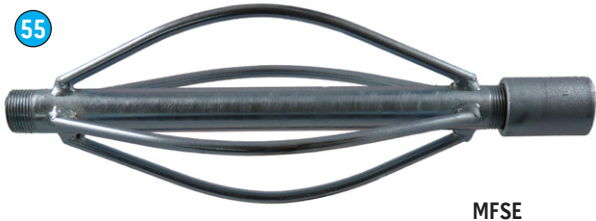

FOOTBALL STYLE NOZZLE EXTENSIONS

1" size	3/4" size		
MFSE-6	MFSE-36	6" NOZZLE EXTENSION	
MFSE-8	MFSE-38	8" NOZZLE EXTENSION	
MFSE-10	MFSE-310	10" NOZZLE EXTENSION	
MFSE-12	MFSE-312	12" NOZZLE EXTENSION	

56

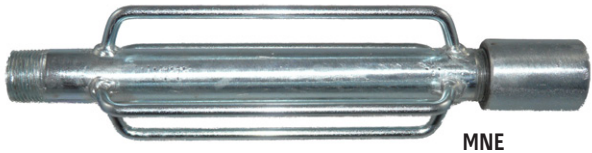

4 WIRE NOZZLE SKID EXTENSIONS

1" size	3/4" size		
MNE-4	MNE-34	4" AND UP NOZZLE EXTENSION	
MNE-6	MNE-36	6" AND UP NOZZLE EXTENSION	
MNE-8	MNE-38	8" AND UP NOZZLE EXTENSION	

57

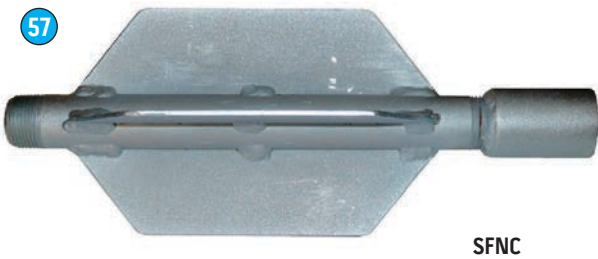

SOLID FINNED NOZZLE EXTENSION

1" size	3/4" size		
SFNC-6	SFNC-36	6" AND UP NOZZLE EXTENSION	
SFNC-8	SFNC-38	8" AND UP NOZZLE EXTENSION	
SFNC-10	SFNC-310	10" AND UP NOZZLE EXTENSION	
SFNC-12	SFNC-312	12" AND UP NOZZLE EXTENSION	

58



FOUR FINNED NOZZLE EXTENSIONS

1" size	3/4" size		
FSE-6	FSE-36	6" AND UP NOZZLE EXTENSION	
FSE-8	FSE-38	8" AND UP NOZZLE EXTENSION	
FSE-10	FSE-310	10" AND UP NOZZLE EXTENSION	
FSE-12	FSE-312	10" AND UP NOZZLE EXTENSION	

NOZZLE EXTENSIONS

SPECIAL WHEELED NOZZLE EXTENSIONS

1" size	3/4" size		
WSE-6	WSE-36	6" AND UP NOZZLE EXTENSION	
WSE-8	WSE-38	8" AND UP NOZZLE EXTENSION	
WSE-10	WSE-310	10" AND UP NOZZLE EXTENSION	
WSE-12	WSE-312	12" AND UP NOZZLE EXTENSION	
WSE-15	WSE-315	15" AND UP NOZZLE EXTENSION	



59

WSE

FIXED 8 WIRE NOZZLE EXTENSIONS

1" size	3/4" size		
MPR-6	MPR-36	NOZZLE EXTENSION FOR 6"	
MPR-8	MPR-38	NOZZLE EXTENSION FOR 8"	
MPR-10	MPR-310	NOZZLE EXTENSION FOR 10"	
MPR-12	MPR-312	NOZZLE EXTENSION FOR 12"	



60

MPR

FIX-FLEX 10 WIRE PROOFERS. SHORT STYLE 15"

1" size	3/4" size		
SDP-060	SDP-360	NOZZLE EXTENSION FOR 6"	
SDP-080	SDP-380	NOZZLE EXTENSION FOR 8"	
SDP-010	SDP-310	NOZZLE EXTENSION FOR 10"	
SDP-012	SDP-312	NOZZLE EXTENSION FOR 12"	

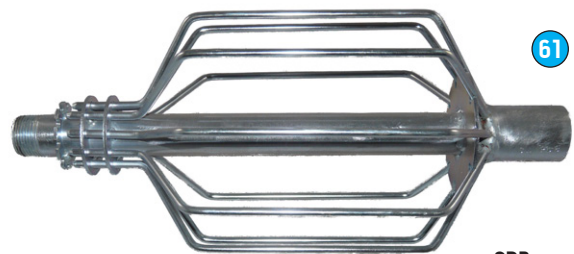

61

SDP

STANDARD STYLE 10 WIRE PROOFER WITH REPLACEABLE SKIDS.

1" size	3/4" size		
MPN-6	MPN-36	NOZZLE EXTENSION FOR 6"	
MPN-7	MPN-37	NOZZLE EXTENSION FOR 7.5"	
MPN-8	MPN-38	NOZZLE EXTENSION FOR 8"	
MPN-9	MPN-39	NOZZLE EXTENSION FOR 9.5"	
MPN-10	MPN-310	NOZZLE EXTENSION FOR 10"	
MPN-11	MPN-311	NOZZLE EXTENSION FOR 11.5"	
MPN-12	MPN-312	NOZZLE EXTENSION FOR 12"	

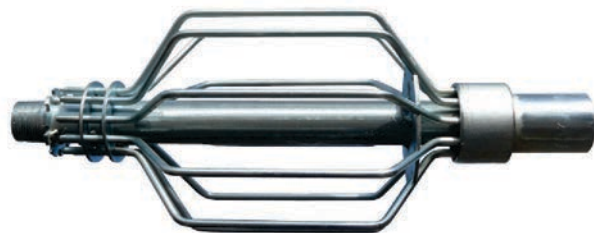

62

MPN

CONTINUOUS ROD, PARTS, TOOLS AND ACCESSORIES

63



MD-37 / MD-57



MC-47 / MC-67

ADAPTER COUPLINGS FOR CONTINUOUS WIRE .375, .393, .415, .461

MC-37	.375 SET SCREW X 3/8" COARSE RH	
MD-37	.393 SET SCREW X 3/8" COARSE RH	
ME-37	.416 SET SCREW X 3/8" COARSE RH	
MF-37	.461 SET SCREW X 3/8" COARSE RH	
MC-47	.375 FINE LH X 5/16" COARSE RH	
MD-47	.393 FINE LH X 5/16" COARSE RH	
ME-47	.416 FINE LH X 5/16" COARSE RH	
MF-47	.461 FINE LH X 5/16" COARSE RH	
MC-57	.375 SET SCREW X 5/16" COARSE RH	
MD-57	.393 SET SCREW X 5/16" COARSE RH	
ME-57	.416 SET SCREW X 5/16" COARSE RH	
MF-57	.461 SET SCREW X 5/16" COARSE RH	
MC-67	.375 FINE LH X 3/8" COARSE RH	
MD-67	.393 FINE LH X 3/8" COARSE RH	
ME-67	.416 FINE LH X 3/8" COARSE RH	
MF-67	.461 FINE LH X 3/8" COARSE RH	

64



MRH7



NUTS FOR CONTINUOUS WIRE

MRH7	.375 RIGHT HAND NUT	
MLH7	.375 LEFT HAND NUT	
MRH9	.393 RIGHT HAND NUT	
MLH9	.393 LEFT HAND NUT	
MRH4	.415 RIGHT HAND NUT	
MLH4	.415 LEFT HAND NUT	
MRH6	.461 RIGHT HAND NUT	
MLH6	.461 LEFT HAND NUT	

65



SSBC

SET SCREW SQUARE BAR COUPLINGS

SSBC-1	.375 SET SCREW COUPLING	
SSBC-2	.393 SET SCREW COUPLING	
SSBC-3	.415 SET SCREW COUPLING	
SSBC-4	.461 SET SCREW COUPLING	

66



DHSC

DIRECT HOOK SQUARE BAR COUPLINGS

DHSC-1	.375 DIRECT HOOK COUPLING	
DHSC-2	.393 DIRECT HOOK COUPLING	
DHSC-3	.415 DIRECT HOOK COUPLING	
DHSC-4	.461 DIRECT HOOK COUPLING	

CONTINUOUS ROD, PARTS, TOOLS AND ACCESSORIES

SET SCREW AUGER COUPLINGS

3", 4", 5"	6" & UP	
SSAC-1	SSAC-6-1	.375 SET SCREW COUPLING
SSAC-2	SSAC-6-2	.393 SET SCREW COUPLING
SSAC-3	SSAC-6-3	.415 SET SCREW COUPLING
SSAC-4	SSAC-6-4	.461 SET SCREW COUPLING



SSAC

67

DIRECT HOOK AUGER COUPLINGS

3", 4", 5"	6" & UP	
DHAC-1	DHAC-6-1	.375 DIRECT HOOK COUPLING
DHAC-2	DHAC-6-2	.393 DIRECT HOOK COUPLING
DHAC-3	DHAC-6-3	.415 DIRECT HOOK COUPLING
DHAC-4	DHAC-6-4	.461 DIRECT HOOK COUPLING



DHAC

68

SET SCREW ROOT SAW COUPLINGS

SSRC-1	.375 SET SCREW COUPLING
SSRC-2	.393 SET SCREW COUPLING
SSRC-3	.415 SET SCREW COUPLING
SSRC-4	.461 SET SCREW COUPLING

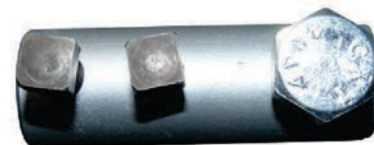

SSRC

69

DIRECT HOOK ROOT SAW COUPLINGS

DHRC-1	.375 DIRECT HOOK COUPLING
DHRC-2	.393 DIRECT HOOK COUPLING
DHRC-3	.415 DIRECT HOOK COUPLING
DHRC-4	.461 DIRECT HOOK COUPLING



DHRC

70

VERSA-CUTTER 3-BLADE CHUCK SET SCREW TYPE

VCSS-1	.375 SET SCREW COUPLING
VCSS-2	.393 SET SCREW COUPLING
VCSS-3	.415 SET SCREW COUPLING
VCSS-4	.461 SET SCREW COUPLING



VCSS

71

VERSA-CUTTER DIRECT HOOKED COUPLING TYPE

VCDH-1	.375 DIRECT HOOK COUPLING
VCDH-2	.393 DIRECT HOOK COUPLING
VCDH-3	.415 DIRECT HOOK COUPLING
VCDH-4	.461 DIRECT HOOK COUPLING



VCDH

72

SPECIAL SEWER RODDER ACCESSORIES

73



TIGER TAIL HOSE PROTECTORS

MTT-1	2" X 36" W/CUFF ENDS AND 24' ROPE	
MTT-2	3" X 36" W/CUFF ENDS AND 24' ROPE	
MTT-3	2" X 48" W/CUFF ENDS AND 24' ROPE	
MTT-4	3" X 48" W/CUFF ENDS AND 24' ROPE	

74

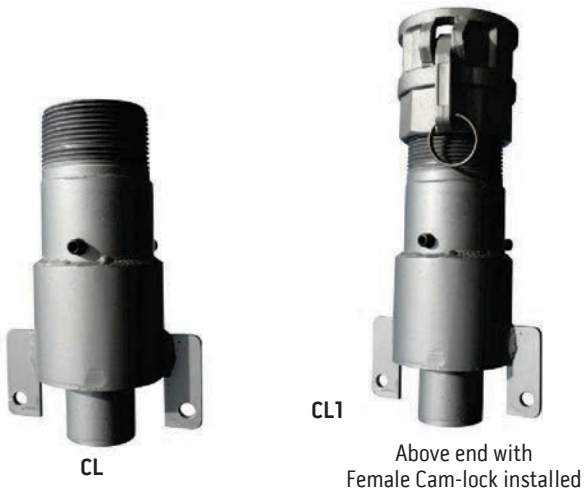

CAM-LOCK STYLE COUPLINGS FOR ABOVE HOSE GUIDES

For those who require cam-lock style ends please Use following guide: Add below part number to above hoses and add extra Price for each end to be cam-lock

CL	2" CAMLOCK ENDS	
CL1	2.5" CAMLOCK ENDS	

75



CAMLOCK STYLE COUPLINGS ONLY

MCL-002	CAMLOCK COUPLING FEMALE 2"	
MCL-001	CAMLOCK COUPLINGS MALE 2"	
MCL-500	CAMLOCK COUPLING FEMALE 2.5"	
MCL-600	CAMLOCK COUPLINGS MALE 2.5"	

SPECIAL SEWER RODDER ACCESSORIES

CAMLOCK STYLE COUPLINGS ONLY

MBA-1	ALUMINUM BELL END HOSE COUPLING
MAE-1	ALUMINUM MALE END HOSE COUPLING
MAE-1S	ALUMINUM MALE END HOSE COUPLING W/SLIP RING
MSM-1	STEEL MALE END
MSF-1	STEEL FEMALE END
MGB-1	ROD GUIDE BELL ONLY
MAL-1	INSERT GUIDES (2 PER HOSE)
MSC-8	FEMALE X FEMALE COUPLER TO MAKE EXTENSIONS.
MSC-9	MALE X FEMALE COUPLER
MHO-2	BLUE HOSE WITH FLEX-METALLIC LINER (PER FOOT)
MHB-2	BLACK HOSE WITH FLEX-METALLIC LINER (PER FOOT)
MRGHD-1	BLACK HOSE WITH SPRING LINER (PER FOOT)
MRGH-LC	CLAMPS FOR GUIDE HOSE COUPLING W/SETS OF 2 BOLTS
MLMB-1	ROD GUIDE BRACE W/ STEEL RING (used with rod guide Bell)
MLMB-2	LIGHTWEIGHT ROD GUIDE BRACE WITH CHAIN AND ROPE
MRS-1	ROD GUIDE TRIANGLE HOSE GUIDE STAND

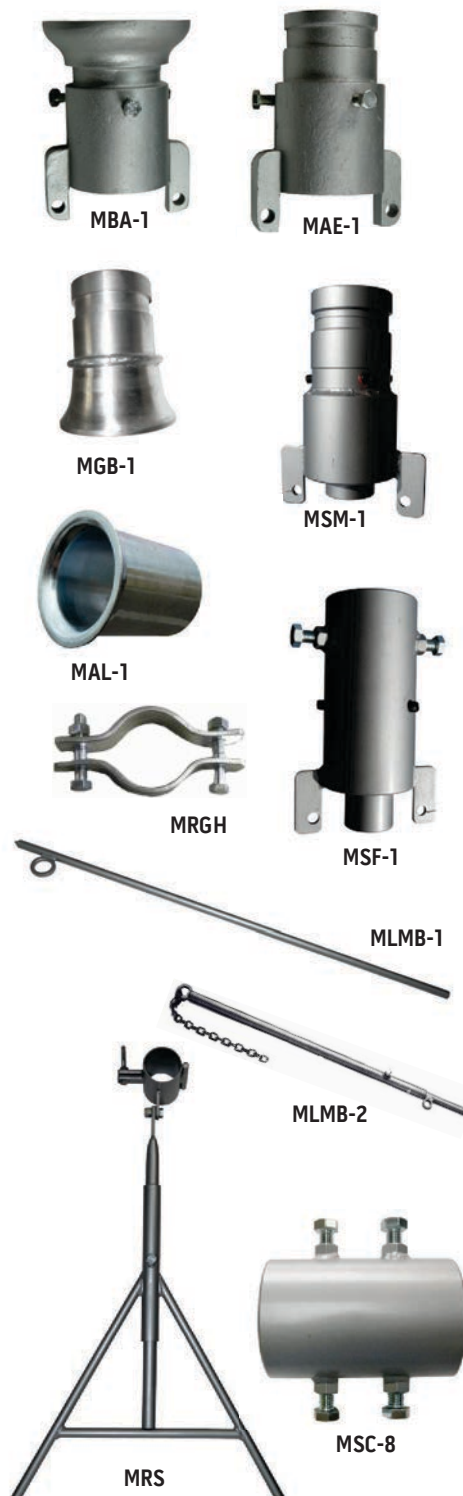

SEWER RODDING EQUIPMENT & ACCESSORIES

77



MPD-3.3



MPD-5



MPD-8.8

M4W



MCC-2

SEWER RODDING MACHINES - GASOLINE POWER

MCC-2	Speedi-Chuck for use with 3/8" rods add	
M4W	4-WHEELED UNIT ADDITIONAL	
HEA-5	HONDA ENGINE DRIVEN UNIT 5 H.P. (ADD)	
MFS-1	Add FLEX-SPEED DRIVE to Power Drive	
MPD-3	3 H.P. MAX-LIFE POWER DRIVE WITH SPEEDI-CHUCK	
MPD-5	5 H.P. MAX-LIFE POWER DRIVE WITH SPEEDI-CHUCK	
MPD-8	8 H.P. MAX-LIFE POWER DRIVE WITH SPEEDI-CHUCK	

78



MR-1



MR-2

HAND SEWER RODDING

MR-1	SINGLE ROD TURNING RATCHET (price per each) Specify 5/16" OR 3/8".	
MR-2	ONE MAN ROD TURNING RATCHETS, Specify 5/16" or 3/8"	

79

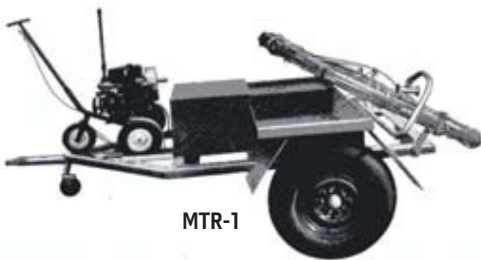

MTR-1

CARRY-ALL TRAILER

MTR-1	CARRY ALL TRAILER (does not include powerdrive or rod reel) (Trailer carries, Power Drive, Rod Reel with Rods and all equipment to job-site)	
MBH2	2" BALL HITCH STANDARD, CHANGE TO PINTLE HITCH	
MTOP	PAINT TRAILER CUSTOM COLOR. Std Color: Black	
MTR-L	STOP, TAIL AND TURNING LIGHTS (includes wiring and connector for truck)	
MEB-1	ELECTRIC BRAKES	

MAX-LIFE MUNICIPAL SEWER RODS

BLUE DIAMOND RODS (SUPER QUALITY) 5/16" or 3/8"

MDA-36	5/16" X 36" BLUE DIAMOND ROD COMPLETE	
MDA-39	5/16" X 39" (1 mt.) BLUE DIAMOND ROD COMPLETE	
MDA-48	5/16" X 48" BLUE DIAMOND ROD COMPLETE	
MDA-60	5/16" X 60" BLUE DIAMOND ROD COMPLETE	
MDA-72	5/16" X 72" BLUE DIAMOND ROD COMPLETE	
MDA-368	3/8" X 36" BLUE DIAMOND ROD COMPLETE	
MDA-398	3/8" X 39" (1mt.) BLUE DIAMOND ROD COMPLETE	
MDA-488	3/8" X 48" BLUE DIAMOND ROD COMPLETE	
MDA-728	3/8" X 72" BLUE DIAMOND ROD COMPLETE	



SILVER DIAMOND RODS (STANDARD QUALTY) 5/16" or 3/8"

MSD-36	5/16" X 36" DIAMOND ROD COMPLETE	
MSD-39	5/16" X 39" (1mt.) DIAMOND ROD COMPLETE	
MSD-48	5/16" X 48" DIAMOND ROD COMPLETE	
MSD-60	5/16" X 60" DIAMOND ROD COMPLETE	
MSD-72	5/16" X 72" DIAMOND ROD COMPLETE	
MSD-368	3/8" X 36" DIAMOND ROD COMPLETE	
MSD-398	3/8" X 39" (1MT.) DIAMOND ROD COMPLETE	
MSD-488	3/8" X 48" DIAMOND ROD COMPLETE	
MSD-728	3/8" X 72" DIAMOND ROD COMPLETE	



COUPLING SETS FOR 5/16" OR 3/8"

5/16"	3/8"	TOOL SIZE	5/16"	3/8"
MC5	MC3	SECTIONAL ROD COUPLINGS		
MRH5	MRH3	RIGHT HAND COARSE THREAD NUT		
MLH5	MLH3	LEFT HAND FINE THREAD NUT		



REPLACEMENT ADAPTER RODS

5/16"	3/8"	TOOL SIZE	5/16"	3/8"
MDA-AD	MDA-A38	ADAPTOR ROD (STD. 8" LONG)		
MDA-SS	MDA8-SS	SUPER SHORT ADAPTOR RO (4.5" LONG)		

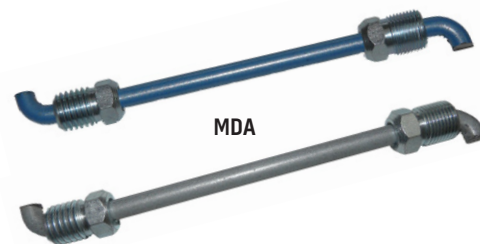

SEWER TOOLS FOR 5/16" & 3/8" RODS

84



MRTF

STANDARD FLAT ROOT SAWS				
5/16"	3/8"		5/16"	3/8"
MRTF-3	MRTF-38	3" PIPE SIZE ROOT SAW		
MRTF-4	MRTF-48	4" PIPE SIZE ROOT SAW		
MRTF-5	MRTF-58	5" PIPE SIZE ROOT SAW		
MRTF-6	MRTF-68	6" PIPE SIZE ROOT SAW		
MRTF-8	MRTF-88	8" PIPE SIZE ROOT SAW		
MRTF-10	MRTF-108	10" PIPE SIZE ROOT SAW		
MRTF-12	MRTF-128	12" PIPE SIZE ROOT SAW		
MRTF-15	MRTF-158	15" PIPE SIZE ROOT SAW		
MRTF-18	MRTF-188	18" PIPE SIZE ROOT SAW		
MRTF-20	MRTF-208	20" PIPE SIZE ROOT SAW		

"FOR BLADE ONLY DEDUCT \$10.00 AND ADD "B" TO ABOVE PART NUMBERS"

85



MRTC

STANDARD CONCAVE ROOT SAWS				
5/16"	3/8"		5/16"	3/8"
MRTC-3	MRTC-38	3" PIPE SIZE ROOT SAW		
MRTC-4	MRTC-48	4" PIPE SIZE ROOT SAW		
MRTC-5	MRTC-58	5" PIPE SIZE ROOT SAW		
MRTC-6	MRTC-68	6" PIPE SIZE ROOT SAW		
MRTC-8	MRTC-88	8" PIPE SIZE ROOT SAW		
MRTC-10	MRTC-108	10" PIPE SIZE ROOT SAW		
MRTC-12	MRTC-128	12" PIPE SIZE ROOT SAW		
MRTC-15	MRTC-158	15" PIPE SIZE ROOT SAW		
MRTC-18	MRTC-188	18" PIPE SIZE ROOT SAW		
MRTC-20	MRTC-208	20" PIPE SIZE ROOT SAW		

"FOR BLADE ONLY DEDUCT \$10.00 AND ADD "B" TO ABOVE PART NUMBERS"

86



DMF

DURA-MAX FLAT ROOT SAWS <small>3/16" Thick for Extra Flexibility Extra Deep Teeth</small>				
5/16"	3/8"		5/16"	3/8"
DMF-3	DMF-38	3" PIPE SIZE ROOT SAW		
DMF-4	DMF-48	4" PIPE SIZE ROOT SAW		
DMF-5	DMF-58	5" PIPE SIZE ROOT SAW		
DMF-6	DMF-68	6" PIPE SIZE ROOT SAW		
DMF-8	DMF-88	8" PIPE SIZE ROOT SAW		
DMF-10	DMF-108	10" PIPE SIZE ROOT SAW		
DMF-12	DMF-128	12" PIPE SIZE ROOT SAW		
DMF-15	DMF-158	15" PIPE SIZE ROOT SAW		
DMF-18	DMF-188	18" PIPE SIZE ROOT SAW		
DMF-20	DMF-208	20" PIPE SIZE ROOT SAW		

"FOR BLADE ONLY DEDUCT \$10.00 AND ADD "B" TO ABOVE PART NUMBERS"

SEWER TOOLS FOR 5/16" & 3/8" RODS

DURA-MAX CONCAVE ROOT SAWS 3/16" Thick for Extra Flexibility Extra Deep Teeth

5/16"	3/8"		5/16"	3/8"
DMC-3	DMC-38	3" PIPE SIZE ROOT SAW		
DMC-4	DMC-48	4" PIPE SIZE ROOT SAW		
DMC-5	DMC-58	5" PIPE SIZE ROOT SAW		
DMC-6	DMC-68	6" PIPE SIZE ROOT SAW		
DMC-8	DMC-88	8" PIPE SIZE ROOT SAW		
DMC-10	DMC-108	10" PIPE SIZE ROOT SAW		
DMC-12	DMC-128	12" PIPE SIZE ROOT SAW		
DMC-15	DMC-158	15" PIPE SIZE ROOT SAW		
DMC-18	DMC-188	18" PIPE SIZE ROOT SAW		
DMC-20	DMC-208	20" PIPE SIZE ROOT SAW		

"FOR BLADE ONLY DEDUCT \$10.00 AND ADD "B" TO ABOVE PART NUMBERS"



87

SHARK ROOT TOOTH SAWS

5/16"	3/8"		5/16"	3/8"
STS-3	STS-38	3" PIPE SIZE SHARK TOOTH SAW		
STS-4	STS-48	4" PIPE SIZE SHARK TOOTH SAW		
STS-6	STS-68	6" PIPE SIZE SHARK TOOTH SAW		
STS-8	STS-88	8" PIPE SIZE SHARK TOOTH SAW		
STS-10	STS-108	10" PIPE SIZE SHARK TOOTH SAW		
STS-12	STS-128	12" PIPE SIZE SHARK TOOTH SAW		

"FOR BLADE ONLY DEDUCT \$10.00 AND ADD "B" TO ABOVE PART NUMBERS"



88

ROUND STOCK CORKSCREWS

5/16"	3/8"		5/16"	3/8"
MCS-1	MCS-18	1.5" O.D. ROUND WIRE CORKSCREW		
MCS-2	MCS-28	2" O.D. ROUND WIRE CORKSCREW		
MCS-2A	MCS-28A	2.5" O.D. ROUND WIRE CORKSCREW		
MCS-3	MCS-38	3" O.D. ROUND WIRE CORKSCREW		
MCS-4	MCS-48	4" O.D. ROUND WIRE CORKSCREW		
MCS-6	MCS-68	6" O.D. ROUND WIRE CORKSCREW		



89

DOUBLE ROUND STOCK CORKSCREWS

5/16"	3/8"		5/16"	3/8"
MCSD-3	MCSD-38	DOUBLE CORKSCREW FOR 3" PIPE		
MCSD-4	MCSD-48	DOUBLE CORKSCREW FOR 4" PIPE		
MCSD-6	MCSD-68	DOUBLE CORKSCREW FOR 6" PIPE		



90

SEWER TOOLS FOR 5/16" & 3/8" RODS

91



MCSS

SQUARE BAR CORKSCREWS

5/16"	3/8"		5/16"	3/8"
MCSS-2	MCSS-28	SQUARE BAR FOR 2" PIPE		
MCSS-3	MCSS-38	SQUARE BAR FOR 3" PIPE		
MCSS-4	MCSS-48	SQUARE BAR FOR 4" PIPE		
MCSS-5	MCSS-58	SQUARE BAR FOR 5" PIPE		
MCSS-6	MCSS-68	SQUARE BAR FOR 6" PIPE		
MCSS-7	MCSS-78	SQUARE BAR 7" O.D. SPECIAL SIZE		
MCSS-8	MCSS-88	SQUARE BAR FOR 8" PIPE		
MCSS-10	MCSS-108	SQUARE BAR FOR 10" PIPE		
MCSS-12	MCSS-128	SQUARE BAR FOR 12" PIPE		

"FOR BLADE ONLY DEDUCT \$10.00 AND ADD "B" TO ABOVE PART NUMBERS"

92



MA

AUGERS

5/16"	3/8"		5/16"	3/8"
MA-2	MA-28	AUGER FOR 2" PIPE SIZE		
MA-3	MA-38	AUGER FOR 3" PIPE SIZE		
MA-4	MA-48	AUGER FOR 4" PIPE SIZE		
MA-5	MA-58	AUGER FOR 5" PIPE SIZE		
MA-6	MA-68	AUGER FOR 6" PIPE SIZE		
MA-8	MA-88	AUGER FOR 8" PIPE SIZE		
MA-10	MA-108	AUGER FOR 10" PIPE SIZE		

"FOR BLADE ONLY DEDUCT \$10.00 AND ADD "B" TO ABOVE PART NUMBERS"

93



MPTT

TURN TYPE PORCUPINES

5/16"	3/8"		5/16"	3/8"
MPTT-6	MPTT-68	TURN TYPE PORCUPINES FOR 6" PIPE		
MPTT-8	MPTT-88	TURN TYPE PORCUPINES FOR 8" PIPE		
MPTT-10	MPTT-108	TURN TYPE PORCUPINES FOR 10" PIPE		
MPTT-12	MPTT-128	TURN TYPE PORCUPINES FOR 12" PIPE		
MPTT-15	MPTT-158	TURN TYPE PORCUPINES FOR 15" PIPE		

SEWER TOOLS FOR 5/16" & 3/8" RODS

DUAL SQUEEGEE TURN TYPE

5/16"	3/8"		5/16"	3/8"
DSE-4	DSE-48	4" PIPE SIZE DUAL SQUEEGEE		
DSE-5	DSE-58	5" PIPE SIZE DUAL SQUEEGEE		
DSE-6	DSE-68	6" PIPE SIZE DUAL SQUEEGEE		
DSE-8	DSE-88	8" PIPE SIZE DUAL SQUEEGEE		
DSE-10	DSE-108	10" PIPE SIZE DUAL SQUEEGEE		
DSE-12	DSE-128	12" PIPE SIZE DUAL SQUEEGEE		
DSE-15	DSE-158	15" PIPE SIZE DUAL SQUEEGEE		
DSE-18	DSE-188	18" PIPE SIZE DUAL SQUEEGEE		



94

TRIPLE SQUEEGEE TURN TYPE

5/16"	3/8"		5/16"	3/8"
DSE3-4	DSE3-48	4" PIPE SIZE TRIPLE SQUEEGEE		
DSE3-5	DSE3-58	5" PIPE SIZE TRIPLE SQUEEGEE		
DSE3-6	DSE3-68	6" PIPE SIZE TRIPLE SQUEEGEE		
DSE3-8	DSE3-88	8" PIPE SIZE TRIPLE SQUEEGEE		
DSE3-10	DSE3-108	10" PIPE SIZE TRIPLE SQUEEGEE		
DSE3-12	DSE3-128	12" PIPE SIZE TRIPLE SQUEEGEE		
DSE3-15	DSE3-158	15" PIPE SIZE TRIPLE SQUEEGEE		
DSE3-18	DSE3-188	18" PIPE SIZE TRIPLE SQUEEGEE		



95

PRO-STEEL HEAVY DUTY BRUSH

5/16"	3/8"		5/16"
HDB-6	HDB-68	6" PIPE SIZE PRO-STEEL SEWER BRUSH	
HDB-7	HDB-78	7" PIPE SIZE PRO-STEEL SEWER BRUSH	
HDB-8	HDB-88	8" PIPE SIZE PRO-STEEL SEWER BRUSH	
HDB-9	HDB-98	9" PIPE SIZE PRO-STEEL SEWER BRUSH	
HDB-10	HDB-108	10" PIPE SIZE PRO-STEEL SEWER BRUSH	
HDB-11	HDB-118	11" PIPE SIZE PRO-STEEL SEWER BRUSH	
HDB-12	HDB-128	12" PIPE SIZE PRO-STEEL SEWER BRUSH	



96

PRO-POLY BRUSH

5/16"	3/8"		5/16"
PPS-6	PPS-68	6" PIPE SIZE PRO-POLY SEWER SWAB	
PPS-7	PPS-78	7" PIPE SIZE PRO-POLY SEWER SWAB	
PPS-8	PPS-88	8" PIPE SIZE PRO-POLY SEWER SWAB	
PPS-9	PPS-98	9" PIPE SIZE PRO-POLY SEWER SWAB	
PPS-10	PPS-108	10" PIPE SIZE PRO-POLY SEWER SWAB	
PPS-11	PPS-118	11" PIPE SIZE PRO-POLY SEWER SWAB	
PPS-12	PPS-128	12" PIPE SIZE PRO-POLY SEWER SWAB	

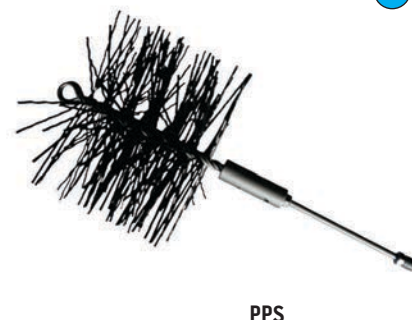

97

SEWER TOOLS FOR 5/16" & 3/8" RODS

98



MSO

CURVED VERSA - CUTTER BLADES

MSO-4	4" BLADES FOR VERSA CHUCK (EACH)	
MSO-6	6" BLADES FOR VERSA CHUCK (EACH)	
MSO-8	8" BLADES FOR VERSA CHUCK (EACH)	
MSO-10	10" BLADES FOR VERSA CHUCK (EACH)	
MSO-12	12" BLADES FOR ABOVE CHUCK (EACH)	

99



MSF

FLAT VERSA-CUTTER BLADES

MSF-4	4" BLADES FOR VERSA CHUCK (EACH)	
MSF-6	6" BLADES FOR VERSA CHUCK (EACH)	
MSF-8	8" BLADES FOR VERSA CHUCK (EACH)	
MSF-10	10" BLADES FOR VERSA CHUCK (EACH)	
MSF-12	12" BLADES FOR VERSA CHUCK (EACH)	

100



MSO-1

VERSA-CUTTER 3-BLADE CHUCK

5/16"	3/8"		5/16"	3/8"
MSO-1	MSO-18	VERSA-CHUCK LESS BLADES		

101



SS

SUNSET SWINGER REVERSE COMBO CUTTER

(DIRECT HOOK OR SET SCREW) COMPLETE WITH BLADES AND SAW.

SS-6	SUNSET SWINGER FOR 6" PIPE	
SS-8	SUNSET SWINGER FOR 8" PIPE	
SS-10	SUNSET SWINGER FOR 10" PIPE	
SS-12	SUNSET SWINGER FOR 12" PIPE	

For .375 add "1" after part numbers, "2" for .393, "3" for .415 and "4" for .461

102



MWR

VERSA CHUCK COMBO CUTTER

5/16"	3/8"	
MWR-6	MWR-68	VERSA CHUCK COMBO CUTTER 6" PIPE
MWR-8	MWR-88	VERSA CHUCK COMBO CUTTER 8" PIPE
MWR-10	MWR-108	VERSA CHUCK COMBO CUTTER 10" PIPE
MWR-12	MWR-128	VERSA CHUCK COMBO CUTTER 12" PIPE

SEWER TOOLS FOR 5/16" & 3/8" RODS

PIPE CLEANING TOOLS

5/16"	3/8"		5/16"	3/8"
MSP-1	MSP-18	SPEAR HEAD 2"		
MSP-2	MSP-28	SPEAR HEAD 4"		
MCSA-4	MCSA-48	SAND CORKSCREW		
MSL-3	MSL-38	SAND LEADER		
MBT-1	MBT-18	BULLET TOOL		
MLT-1W	MLT-1W8	SWIVEL LOOP TOOL		
MLL-1	MLL-18	LATERAL LOCATOR		
MBTS-1	MBTS-18	SWIVEL BULLET PULL OUT TOOL		



MSP-1



MSP-2



MLT



MSL



MLL



MBT



MCSA



MBTS

SEWER TOOLS FOR 5/16" & 3/8" RODS

104



P5-6M



P5-2M

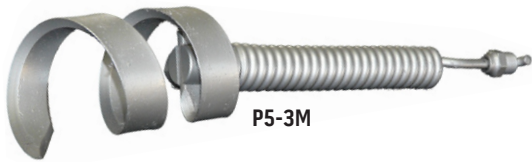

P5-3M

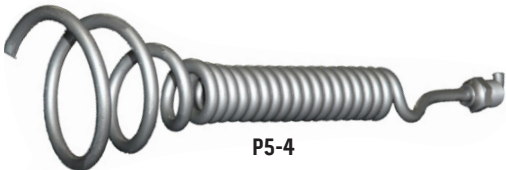

P5-4

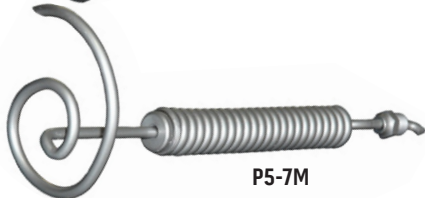

P5-7M



P5-3M

THE FOLLOWING ARE STANDARD NO. 5 PLUMBER TOOLS WITH 1" x 12" LONG FLEXIBLE COILED ROD LEADER WITH SPECIAL HIGHER TORQUE 5/16" PIG TAIL TO FIT YOUR 5/16" ROD COUPLING HIGHLY RECOMMENDED IN POWER DRIVE OR HAND RODDING SETS IN 4"-6" LINES WITH BENDS.

SPECIAL TOOLS FOR MUNICIPAL RODDING

5/16"	TOOL SIZE	5/16"
P5-2M	2" CORKSCREW	
P5-3M	4" DOUBLE CORKSCREW	
P5-4M	4" CORKSCREW	
P5-5-2M	2" ROOT CUTTER	
P5-5-3M	3" ROOT CUTTER	
P5-5-4M	4" ROOT CUTTER	
P5-5-6M	6" ROOT CUTTER	
P5-6M	SPEAR HEAD	
P5-7M	PICK UP TOOL	

105



MC

5/16" x 3/8" SECTIONAL ROD ADAPTER COUPLINGS

MC-35	3/8" FINE L/H X 5/16" COARSE R/H. REPLACE 3/8" END COUPLING WITH MC-35 TO CONNECT TO 5/16" TOOL OR ROD	
MB-36	5/16" FINE LH X 3/8" COARSE RH REPLACE 5/16" END COUPLING WITH MB-36 TO CONNECT TO 3/8" TOOL OR RODS	

SPECIAL TOOLS FOR LINED PIPE

THE FOLLOWING TOOLS ARE COATED WITH A SPECIALLY FORMULATED FUSION BONDED EPOXY BLENDED WITH QUARTZ SILICA TO A TENSILE STRENGTH OF 7300 PSI. RESISTANT TO SEWAGE, CALCIUM CARBONATE, H₂S, BENZENE, CARBON DISULFIDE, ETHANE AND METHANE AND MANY MORE. THIS PROTECTION OF THE STEEL TOOL UNDERNEATH ASSURES THAT YOUR LINING WILL NOT BE SCRAPPED OR SCARRED. IN ADDITION, THESE SPECIAL TOOLS ARE UNDERSIZED TO ACCOMMODATE LINED PIPE.

COATED CONCAVE ROOT SAW FOR LINED PIPE

5/16"	3/8"		5/16"	3/8"
LMRT-5	LMRT-58	SPECIAL COATED CONCAVE SAW EXACTLY 5"		
LMRT-6.5	LMRT-6.58	SPECIAL COATED CONCAVE SAW EXACTLY 6.5"		
LMRT-7	LMRT-78	SPECIAL COATED CONCAVE SAW EXACTLY 7"		

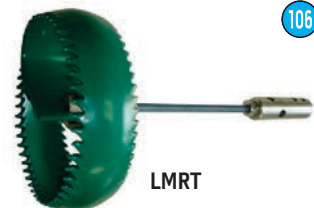

COATED CURVED 3-BLADE CUTTER FOR LINED PIPE

5/16"	3/8"		5/16"	3/8"
LMS-55	LMS-558	SPECIAL COATED 3 BLADE CUTTER & CHUCK 5.5"		
LMS-75	LMS-758	SPECIAL COATED 3 BLADE CUTTER & CHUCK 7.5"		
LMS-95	LMS-958	SPECIAL COATED 3 BLADE CUTTER & CHUCK 9.5"		
LMS-115	LMS-1158	SPECIAL COATED 3 BLADE CUTTER & CHUCK 11.5"		

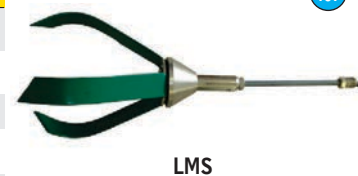

COATED AUGER FOR LINED PIPE

5/16"	3/8"		5/16"	3/8"
LMA-3	LMA-38	SPECIAL COATED SEWER AUGER. EXACTLY 3"		
LMA-3.5	LMA-3.58	SPECIAL COATED SEWER AUGER. EXACTLY 3.5"		
LMA-4.5	LMA-4.58	SPECIAL COATED SEWER AUGER. EXACTLY 4.5"		
LMA-7	LMA-78	SPECIAL COATED SEWER AUGER. EXACTLY 7"		



COATED FOOTBALL STYLE NOZZLE EXTENSIONS

1" size	3/4" size		
LMFSE-6	LMFSE-36	6" NOZZLE EXTENSION	
LMFSE-8	LMFSE-38	8" NOZZLE EXTENSION	
LMFSE-10	LMFSE-310	10" NOZZLE EXTENSION	
LMFSE-12	LMFSE-312	12" NOZZLE EXTENSION	



COATED 4 WIRE NOZZLE SKID EXTENSIONS

1" size	3/4" size		
LMNE-6	LMNE-36	4" AND UP NOZZLE EXTENSION	
LMNE-8	LMNE-38	6" AND UP NOZZLE EXTENSION	
LMNE-10	LMNE-310	8" AND UP NOZZLE EXTENSION	
LMNE-12	LMNE-312	10" AND UP NOZZLE EXTENSION	



COATED FIX-FLEX 10 WIRE PROOFER

1"	3/4"		
LSDP-5	LSDP-35	5" COATED FIX-FLEX 10 WIRE PROOFER	
LSDP-7	LSDP-37	7" COATED FIX-FLEX 10 WIRE PROOFER	



SEWER TOOLS FOR 5/16" & 3/8" RODS

112

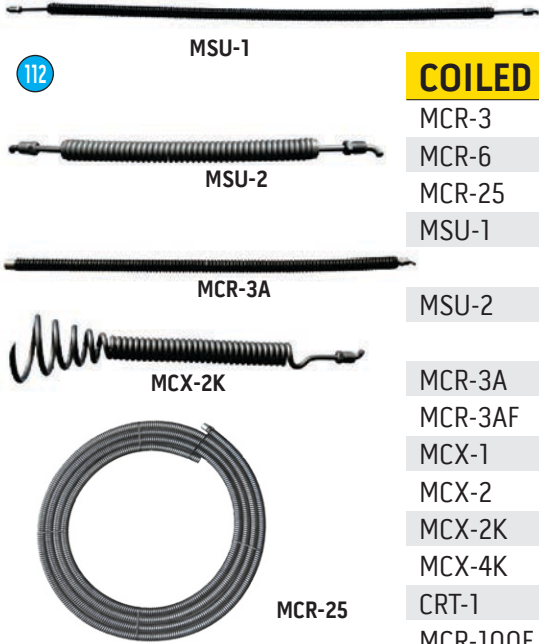

COILED ROD TOOLS LEADERS & MUNICIPAL CABLES

MCR-3	1" X 3' COILED ROD W/ LH X RH PIG TAILS FOR 5/16" RODS	
MCR-6	1" X 6' COILED ROD W/ LH X RH PIG TAILS FOR 5/16" RODS	
MCR-25	1" X 25' COILED ROD W/ LH X RH PIG TAILS FOR 5/16" RODS	
MSU-1	1" O.D. OF 1/4" X 12' LONG WIRE SPRING WITH 5/16" PIG TAILS ONE ON EACH END COARSE X FINE	
MSU-2	1-1/4" O.D. OF 5/16" X 12" LONG WIRE SPRING WITH 5/16" PIG TAIL ON EACH END	
MCR-3A	3' X 1" COARSE RH PIGTAIL X AUGER COUPLING FOR 3"-4"	
MCR-3AF	3' X 1" AUGER COUPLING X FEMALE FINE "B" COUPLING	
MCX-1	2" TAPERED CORKSCREW , 5/16" MATERIAL x 18" LONG, "B" NUT	
MCX-2	4" TAPERED CORKSCREW , 5/16" MATERIAL x 18" LONG, "B" NUT	
MCX-2K	2" TAPERED CORKSCREW , 5/16" MATERIAL x 12" LONG, "B" NUT	
MCX-4K	4" TAPERED CORKSCREW , 5/16" MATERIAL x 12" LONG, "B" NUT	
CRT-1	COILED ROD TURNING HANDLE	
MCR-100F	100' COILED ROD 1" dia with FEED THRU COUPLINGS	

113

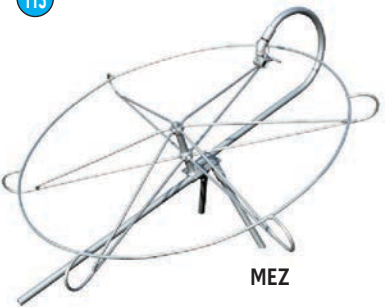

ROD STORAGE REEL AND REEL STAND

MEZ-1	ROD STORAGE REEL, holds up to 200 each of 39" Rods	
MEZ-2	ROD REEL STAND, Supports Reel on ground enables one man to pull Rods off or push Rods on Reel while supported on street.	
MEZ-3	ROD REEL STAND, Supports Reel ON Carry-All trailer	

114

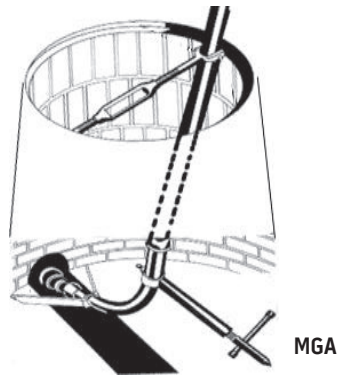

QUICK CONNECT, 1 1/2" STEEL OR ALUMINUM ROD GUIDE ASSEMBLY (complete as pictured)

MGA-21	(Guides Rod from street down manhole to sewer) Complete 21 ft Rod Guide consisting of the following: MGJ-1 Rod guide Manhole Jack, Sections steel pipe with cam lock connections in 7', 5', 5', 3' sections and 2 ft. MRG-1 Lower Manhole Rigid Rod Guide, MFJ-1 Adjustable Foot Jack and MBJ-1 Back Jack. Each pipe Section has quick connect Couplings for fast assembly to varying depths.	
--------	---	--

CONTINUOUS ROD, PARTS, TOOLS AND ACCESSORIES

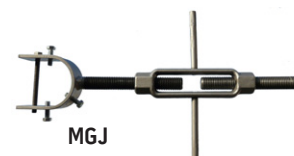

115

ROD GUIDE COMPONENTS Customer supplies 1-1/2" Guide Pipes

MGJ-1	ROD GUIDE MANHOLE JACK	
MRG-1	LOWER MANHOLE RIGID ROD GUIDE	
MFJ-1	ADJUSTABLE FOOT JACK	
MBJ-1	ADJUSTABLE BACK JACK (for extra stability add this Jack)	

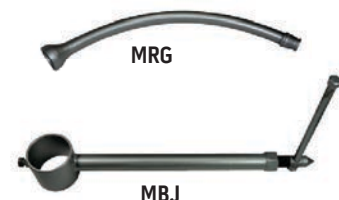

ROD CONNECTING & HANDLING TOOLS

5/16"	3/8"		5/16"	3/8"
MAT-1	MAT-18	ASSEMBLY WRENCH, USED FOR TIGHTENING ROD CONNECTION		
MAH-1	MAH-18	ASSEMBLY TURNING HANDLE, TO STEADY RODS WHILE CONNECTING		
MPU-1	MPU-18	PICK-UP TOOL FOR SECTIONAL RODS		
MPT-1	MPT-18	PULL OUT TOOL FOR RODS- PUSH/PULL TOOL		
MPT-2	MPT-28	PULL-OUT TURNING HANDLE- PUSH/PULL/TURN		
MBH-1	MBH-18	BAR TURNING HANDLE - SHORT MANUAL TURNS		
MRP-1		ROUND ROD PULLER 1/4" TO 3/8" RODS		
MRP-2		ROD PULLER HITCH		

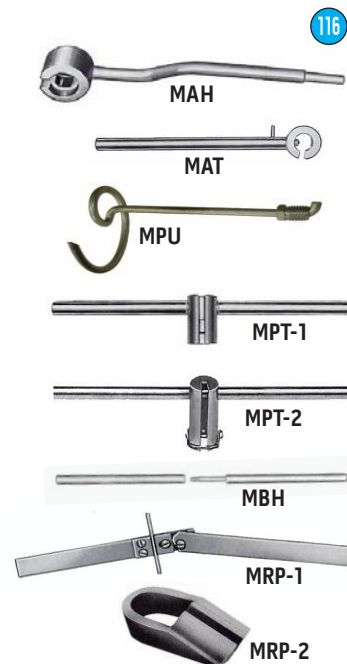

116

TOOL COUPLINGS FOR 5/16" - 3/8" RODS

5/16"	3/8"		5/16"	3/8"
SBC-5	SBC-3	SQUARE BAR CORKSCREW COUPLINGS		
RSC-5	RSC-3	ROOT SAW COUPLING WITH SIDE BOLT		
RAC-5	RAC-3	3" AND 4" AUGER COUPLINGS WITH SIDE BOLT		
RAC-5U	RAC-3U	5" AND UP AUGER COUPLING WITH SIDE BOLT		
MWR-1	MWR-48	WINTERS DOUBLE ROOT SAW COUPLING		



117

MANUAL 1/4" X 6' PLUMBERS RODS & TOOLS

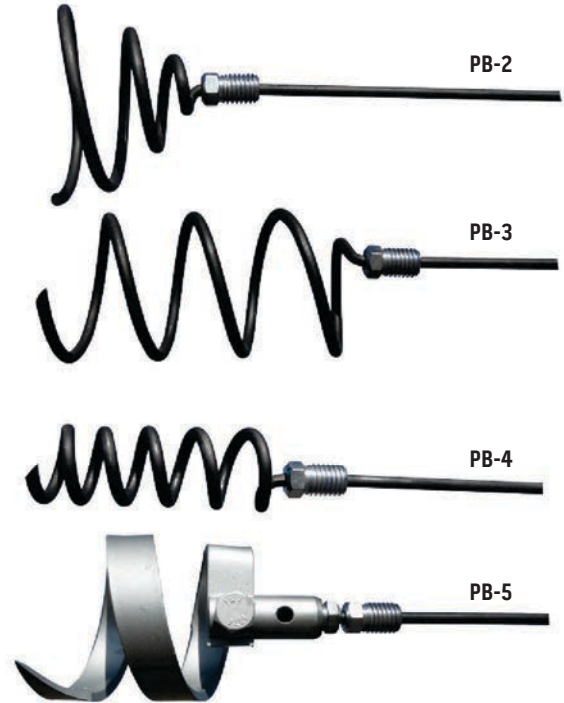

118

"B" PLUMBERS SET FOR 106' STRAIGHT RUNS IN SMALL DIA. PIPE

PB	COMPLETE NO. 5 SET INCLUDES THE FOLLOWING:
	17 EACH OF 1/4" X 6' RODS COMPLETE
	1 EACH OF P5-1 ROD FRAME
	1 EACH OF P5-2 2" CORKSCREW
	1 EACH OF P5-3 4" DOUBLE CORKSCREW
	1 EACH OF P5-4 4" CORKSCREW
	1 EACH OF P5-5 ROOT CUTTER
	1 EACH OF P5-6 SPEAR HEAD
	1 EACH OF P5-7 PICK UP TOOL
	1 EACH OF P5-8 ASSEMBLY TOOL
	1 EACH OF P5-9 ELECTRIC DRILL ADAPTER
	1 EACH OF P5-10 TURNING HANDLE
	PRICE FOR COMPLETE NO. 5 SET

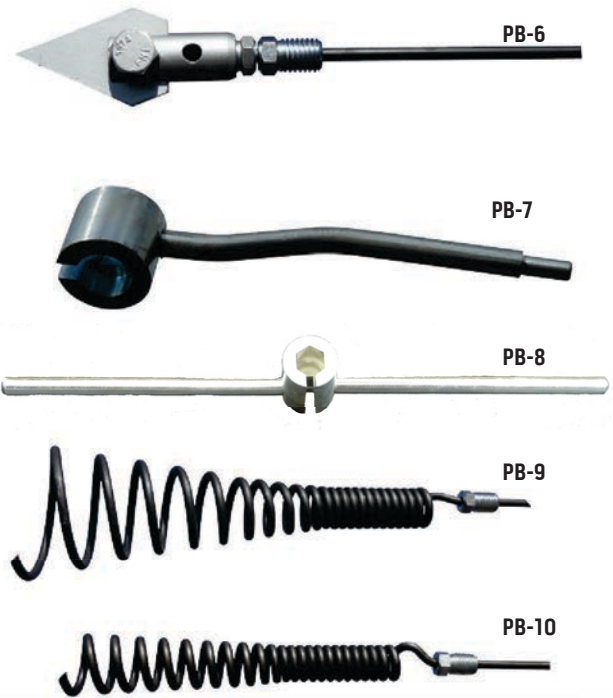

119

PB-1	1/4" X 6' RODS COMPLETE
PB-2	PICK UP TOOL
PB-3	4" CORKSCREW
PB-4	2" CORKSCREW
PB-5-3	3" ROOT CUTTER
PB-5-4	4" ROOT CUTTER
PB-6	SPEAR HEAD
PB-7	ASSEMBLY TOOL
PB-8	TURNING HANDLE
PB-9	4" TAPERED CORKSCREW (NOT INCLUDED IN SET)
PB-10	2" TAPERED CORKSCREW (NOT INCLUDED IN SET)

MANUAL 1/4" X 6' PLUMBERS RODS & TOOLS

NO. "5" SET, 110' WITH SPRING LEADERS FOR LINES WITH BENDS

120

P-5 COMPLETE NO. 5 SET INCLUDES THE FOLLOWING:

P-5	17 EACH OF 1/4" X 6' RODS COMPLETE
	1 EACH OF P5-1 ROD FRAME
	1 EACH OF P5-2 2" CORKSCREW
	1 EACH OF P5-3 4" DOUBLE CORKSCREW
	1 EACH OF P5-4 4" CORKSCREW
	1 EACH OF P5-5 ROOT CUTTER
	1 EACH OF P5-6 SPEAR HEAD
	1 EACH OF P5-7 PICK UP TOOL
	1 EACH OF P5-8 ASSEMBLY TOOL
	1 EACH OF P5-9 ELECTRIC DRILL ADAPTER
	PRICE FOR COMPLETE NO. 5 SET

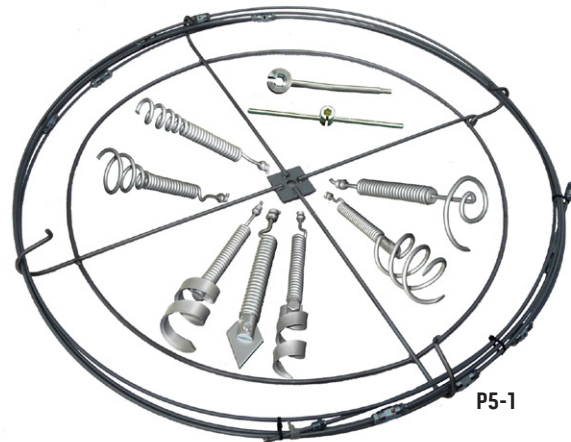

P5-1



P5-6



P5-2

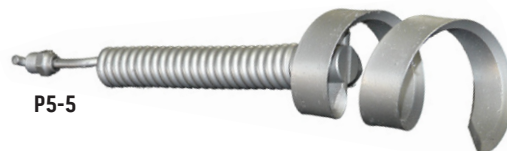

P5-5



P5-4



P5-7



P5-3M

121

P5-13	1/4" X 6' ROD COMPLETE
P5-1	ROD FRAME
P5-2 2"	CORKSCREW
P5-3 4"	DOUBLE CORKSCREW
P5-4 4"	CORKSCREW
P5-5-2	2" ROOT CUTTER
P5-5-3	3" ROOT CUTTER
P5-5-4	4" ROOT CUTTER
P5-6	SPEAR HEAD
P5-7	PICK UP TOOL
P5-8	ASSEMBLY TOOL
P5-9	ELECTRIC DRILL ADAPTER
P5-10	PULL OUT / TURNING HANDLE (HEX CENTER)



P5-8



P5-9



P5-10

MAX-LIFE BUCKET MACHINES

122

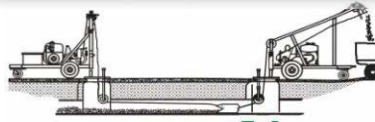

BUCKET MACHINES (MECHANICAL)

10 H.P. GASOLINE ENGINE MODELS

MPI-10	PULL IN MACHINE WITH 78" SHORT FRAME NO TOOL BOX	
MLT-10	TRUCK LOADER MACHINE FOR 6" TO 22" BUCKETS	

18 H.P. GASOLINE ENGINE MODELS

MPI-18	PULL IN MACHINE WITH 78" SHORT FRAME NO TOOL BOX	
MLT-18	TRUCK LOADER MACHINE FOR 6" TO 22" BUCKETS	
MLT-18HD	HEAVY DUTY TRUCK LOADER FOR 6" TO 24" BUCKETS	

30 H.P. GASOLINE ENGINE MODELS

MPI-30	PULL IN MACHINE WITH LONG FRAME NO TOOL BOX	
MLT-30	TRUCK LOADER MACHINE FOR 6" TO 22" BUCKETS	
MLT-30HD	HEAVY DUTY TRUCK LOADER FOR 6" TO 30" BUCKETS	

65 H.P. DIESEL ENGINE MODELS

MPI-20D	PULL IN MACHINE WITH 78" SHORT FRAME NO TOOL BOX	
MLT-20D	TRUCK LOADER MACHINE FOR 6" TO 22" BUCKETS	
MLT-20HD	HEAVY DUTY TRUCK LOADER FOR 6" TO 30" BUCKETS	



PULL-IN MACHINE



SMALL TRUCK LOADER

123

BUCKET MACHINES (HYDRAULIC)

30 H.P. GASOLINE ENGINE MODELS

MPI-30	PULL IN MACHINE WITH 78" SHORT FRAME NO TOOL BOX	
MLT-30	TRUCK LOADER MACHINE FOR 6" TO 24" BUCKETS	
MLT-30HD	HEAVY DUTY TRUCK LOADER FOR 6" TO 30" BUCKETS	

37 H.P. GASOLINE ENGINE MODELS

MPI-37	PULL IN MACHINE WITH 78" SHORT FRAME NO TOOL BOX	
MLT-37	TRUCK LOADER MACHINE FOR 6" TO 24" BUCKETS	
MLT-37HD	HEAVY DUTY TRUCK LOADER FOR 6" TO 30" BUCKETS	

65 H.P. DIESEL ENGINE MODELS

MPI-65	PULL IN MACHINE WITH 78" SHORT FRAME NO TOOL BOX	
MLT-65	TRUCK LOADER MACHINE FOR 6" TO 22" BUCKETS	
MLT-65HD	HEAVY DUTY TRUCK LOADER FOR 6" TO 30" BUCKETS	



LARGE TRUCK LOADER

MAX-LIFE BUCKET MACHINES

BUCKET MACHINE OPTIONS

124

	PER MACHINE
THREE SPEED AUTOMOTIVE TYPE TRANSMISSION	
2-SPEED HYDRAULIC OPTION	
HYDRAULIC CONTROLLED LIFT LEGS (2 EACH PER MACH)	
SPRING LOADED ANTI-BACKLASH UPPER ROLLER	
BUCKET ARM AND CHAIN FOR MANUAL DUMPING	
ENGINE SHIELD COVER FOR TRUCK LOADER	
WRENCH TOOL BOX WITH HINGED LID AND PADLOCK	
PINTLE RING HITCH MOUNTED	
6-PLY RATED TIRES IN LIEU OF 4 PLY	
70 AMP BATTERY	
LARGER THAN 600CCA BATTERY	
BUCKET LOCATION METER	
ENGINE OIL PRESSURE GAUGE	
EMERGENCY CRANK HANDLE	
STOP DIRECTIONAL TAIL LIGHTS	
SAFETY CHAINS	
FENDERS	
ELECTRIC BRAKES	
ROTATING BEACON	
TACHOMETER	
BATTERY BOX	
HOUR METER	
VOLTAGE METER	
KEY IGNITION	
OVERNIGHT DRUM	
1/2" PREFORMED WIRE ROPE WITH HEMP CENTER (PER FT)	
1/4" PLOW STEEL OVERNIGHT CABLE (PER FT)	
SCROLL	

MAX-LIFE BUCKET MACHINES

125



MB

HEAVY DUTY BUCKETS

MB-6	HEAVY DUTY BUCKET FOR 6" PIPE	
MB-8	HEAVY DUTY BUCKET FOR 8" PIPE	
MB-10	HEAVY DUTY BUCKET FOR 10" PIPE	
MB-12	HEAVY DUTY BUCKET FOR 12" PIPE	
MB-15	HEAVY DUTY BUCKET FOR 15" PIPE	
MB-18	HEAVY DUTY BUCKET FOR 18" PIPE	
MB-22	HEAVY DUTY BUCKET FOR 22" PIPE	
MB-24	HEAVY DUTY BUCKET FOR 24" PIPE	
MB-30	HEAVY DUTY BUCKET FOR 30" PIPE	
MB-36	HEAVY DUTY BUCKET FOR 36" PIPE	

126



MPP

HEAVY DUTY PULL TYPE PORCUPINES

MPP-6	HEAVY DUTY PULL TYPE PORCUPINE FOR 6" PIPE	
MPP-8	HEAVY DUTY PULL TYPE PORCUPINE FOR 8" PIPE	
MPP-10	HEAVY DUTY PULL TYPE PORCUPINE FOR 10" PIPE	
MPP-12	HEAVY DUTY PULL TYPE PORCUPINE FOR 12" PIPE	
MPP-15	HEAVY DUTY PULL TYPE PORCUPINE FOR 15" PIPE	
MPP-18	HEAVY DUTY PULL TYPE PORCUPINE FOR 18" PIPE	
MPP-20	HEAVY DUTY PULL TYPE PORCUPINE FOR 20" PIPE	
MPP-22	HEAVY DUTY PULL TYPE PORCUPINE FOR 22" PIPE	
MPP-24	HEAVY DUTY PULL TYPE PORCUPINE FOR 24" PIPE	
MPP-30	HEAVY DUTY PULL TYPE PORCUPINE FOR 30" PIPE	
MPP-36	HEAVY DUTY PULL TYPE PORCUPINE FOR 36" PIPE	

MAX-LIFE BUCKET MACHINES

BUCKET MACHINE ACCESSORIES

127

MSH-8	SURFACE HUNG MANHOLE ROLLER & YOKE 8"
MSH-12	SURFACE HUNG MANHOLE ROLLER & YOKE 12"
MSH-15	SURFACE HUNG MANHOLE ROLLER&YOKE 15"
MSH-15W	SURFACE HUNG MANHOLE ROLLER & YOKE 15" WIDE FLANGE
SHP-1	SURFACE HUNG PLATFORM VICE PIPE HOLDER
MMR-8	8" ROLLER WITH JACKS (TRENCH TYPES)
MMR-12	12" ROLLER WITH JACKS (TRENCH TYPES)
MMR-15	15" ROLLER WITH JACKS (TRENCH TYPES)
MMR-15W	15" ROLLER WITH WIDE FLANGE INCL. TRENCH JACKS
SJR-1	ADJUSTABLE SLANT JACK
SJR-1H	HEAVY DUTY SLANT JACK WITH WIDE ROLLER
BF-22	BUCKET LEADER FOR BUCKETS UP TO 22"
BF-24	BUCKET LEADER FOR BUCKETS 24" AND UP
HH-1	SHORT HAND HOOKS
HH-2	LONG HAND HOOKS
SH-3	BALL BEARING SWIVEL WITH EYE AND SHACKLE
SH-3A	BALL BEARING SWIVEL WITH DOUBLE EYE

Note: Please deduct \$200.00 from any roller and yoke if only the roller is needed.

I N M E M O R Y O F



Neil McDowell

This catalog is dedicated to our founder and President Neil McDowell, who at the young age of 95, passed away in December of 2011. Neil came to work every day and was very involved in the continued growth of Max-Life. He reminded everyone of us that we make quality tools and equipment for our customers and also ensured outstanding customer service came with our products. Neil's visions will be carried on by those who respected him and worked side by side with him.

EQUIPMENT | TOOLS | ACCESSORIES

MAX-LIFE
SEWER CLEANING TOOLS 

Max-Life Manufacturing Corp.

11580 Seaboard Circle • Stanton, CA 90680

Toll Free: (888) 873-6295 • (714) 898-4830 • Fax: (714) 897-2810

www.flexmax.com